

NEWKer



Make the most ideal and practical product to serve CNC world

NEW990MDC Controller

Operation Manual

CHENGDU NEWKer CNC-TECHNOLOGY CO., LTD

CONTENTS

Chapter 1 Preface	1
Chapter 2 Controller installation and connection	2
2.1 System electrical specification.....	2
2.2 System technical index.....	2
2.3 Environment of operation.....	2
2.4 System installation and connection.....	2
2.5 Controller dimension.....	3
2.6 controller rear view.....	3
2.7 Interface connection graph.....	4
2.7.1 Communication CN6 female socket (DB9).....	4
2.7.2 IO 1 signal CN3 female socket(DB25).....	5
2.7.3 IO 2 signal CN10 female socket(DB25).....	6
2.7.4 Servo driver signal CN5 male socket(DB25).....	7
2.7.5 External switch, electrical handwheel CN11 male socket(DB15).....	8
2.7.6 Spindle encoder CN9 male socket(DB9).....	10
2.7.7 Position feedback signal CN13 male socket(DB26).....	10
2.7.8 Parameter setting with absolute motor.....	11
2.8 Installation of machine electronic parts	12
2.8.1 Limit position.....	12
2.8.2 Machine home point(reference point or 0 point).....	13
2.8.3 Switch signal control.....	16
2.8.4 System alarm signal.....	18
2.8.5 User-defined output signal M12.....	19
2.9 Electrical element control board(optional).....	19
2.9.1 Spindle control.....	20
2.9.2 Spindle gear control.....	20
2.10 Relay board(optional).....	20
Chapter 3 Operation	22
3.1 Summary.....	22
3.2 Operation panel.....	22
3.3 Keyboard description.....	22
3.3.1 Rate increase or decrease.....	22
3.3.2 Usage for intervention switch.....	22
3.3.3 Others keys.....	22
3.4 Manual operation.....	24
3.4.1 Manual button operation.....	25
3.4.2 Manual continuous.....	26
3.4.3 Manual increment.....	27

3.4.4 Back to machine home point (reference point).....	27
3.4.5 Handwheel(MPG).....	28
3.5 Auto operation.....	29
3.5.1 Automatical process.....	29
3.5.2 Processing at arbitrary program line or with arbitrary tool.....	30
3.5.3 Start program.....	30
3.5.4 Stop processing program.....	30
3.5.5 Real-time control in automatic process.....	30
3.5.6 Operation of MDI.....	31
3.5.7 Operation of Handwheel.....	32
3.5.8 Function of DNC.....	32
3.6 Operate safety, Alarm.....	33
3.6.1 Emergency stop.....	33
3.6.2 Reset system.....	33
3.6.3 Alarm.....	33
3.7 Parameter operation.....	34
3.7.1 User parameter (processing).....	34
3.7.2 Speed parameter.....	37
3.7.3 Axis parameter.....	43
3.7.4 Tool parameter.....	49
3.7.5 Other parameter.....	50
3.7.6 Coordinate system.....	60
3.7.7 Password.....	63
3.8 Tool compensation.....	63
3.8.1 Radius compensation.....	63
3.8.2 Length compensation.....	64
3.8.3 Posit tool.....	64
3.8.4 Set quantity.....	65
3.9 Screw compensation.....	65
3.10 Diagnosis.....	69
3.11 Operation of program.....	72
3.11.1 Editing.....	73
3.11.2 Copy.....	75
3.11.3 Delete.....	75
3.11.4 Rename.....	75
3.11.5 Information.....	75
3.11.6 Checking program.....	76
3.11.7 Folder management.....	76
3.11.8 Select automatic program to run.....	76
3.11.9 Program communication.....	76
3.11.10 U-disk management.....	76
3.11.11 Convert DXF files into G code.....	78
Chapter 4 Programming.....	79

4.1 Basic concepts.....	79
4.2 General description of program.....	80
4.3 Program instruction.....	80
4.3.1 Functional meaning of address symbol,data list.....	80
4.3.2 Program instruction.....	81
4.4 Programme instruction and usage.....	90
4.4.1 Programme convention.....	90
4.4.2 Instruction of G function.....	90
(1) Choose instruction of coordinate system.(G53/G54/G55/G56/G57/G58/G59).....	90
(3) Coordinate system instruction.....	91
(3) Program method(G90/G91).....	91
(4) Select Plane(G17/G18/G19).....	92
(5) Rapid motion(G00).....	92
(6) Line interpolation(G01).....	92
(7) Arc interpolation(G02/G03).....	92
(8) Spiral interpolation (G02/G03).....	94
(9) Three dimension space arc instruction(G06).....	95
(10) Delay instruction(G04).....	96
(11) Mirror instruction(G11/G12).....	96
(12) Proportions scale instruction(G36/G37).....	97
(13) Coordinate rotate(G68/G69).....	98
(14) Return reference point(Zero point) (G28/G281/G282/G283/G284/G301/G302/ G303/G304).....	100
(15) Tool length compensation instruction(G43/G44/G49).....	100
(16) Offset of tool radius instruction(G45/G46/G47/G48).....	101
(17) Tool radius compensate instruction(G40/G41/G42).....	102
(18) Program circulation instruction (G22--G800).....	104
(19) Accurate localization/Continual way processing (G60/G64).....	105
(20) Circle instruction (G73、G74、G80~G89).....	105
(21) High speed drill deep hole(G73).....	107
(22) Drilling cycle, point drilling cycle(G81).....	108
(23) Drilling cycle,Reaming cycle(G82).....	109
(24) Intermission drill cycle (G83).....	110
(25) Boring cycle(G85).....	111
(26) Boring cycle(G86).....	112
(27) Boring cycle, Back boring cycle(G87).....	113
(28) Boring cycle(G89).....	114
(29) Finishing boring cycle(G76).....	115
(30) Left tap cycle(G74).....	116
(31) Right tap cycle(G84).....	117
(32) Cancel cycle instruction (G80).....	118
(33) Pole coordinate instruction(G15/G16).....	118
(34) Metric system and British system(G20/G21), Feeding method(G94/G95).....	120
(35) Back to start point of program(G26/G261-G264).....	121

(36) Memory the current point(G25).....	121
(37) Return to the memorial point(G61/G611-G618).....	121
(38) Check skip(G31、G311).....	122
(39) Automatic beveling (I) and smoothing(R).....	122
(40) Program call(M97 M98 M99).....	123
(41) Feeding speed F function.....	126
(42) T/H/D function.....	126
(43) Spindle speed S, SS.....	126
(44) Macro program instruction(G65,G66,G67).....	126
(45) User-defined macro instruction(G101-G170,M880-M889).....	131
(46) Rough milling of groove in circle G110/G111:.....	132
(47) Finishing milling cycle of inner circle G112/G113.....	134
(48) Finishing milling cycle of outer circle G114/G115.....	136
(49) Rough milling cycle of excircle G116/G117.....	137
(50) Rough milling cycle of outer rectangle G132/G133.....	139
(51) Rough milling cycle of rectangle groove G134/G135.....	141
(52) Finishing milling cycle of inner rectangle groove G136/G137.....	144
(53) Finishing milling cycle of outer rectangle groove G138/G139/G141/G142.....	145
(54) Programmable data input instruction G10/G710.....	146
(55) Programmable data input instruction G10.....	147
(56) Ellipse instruction(G602/G603).....	148
(57) Parabola instruction(G702).....	148
4.5 Radius compensation C of tool.....	149
4.5.1 Inside and outside.....	149
4.5.2 Tool motion when starting.....	149
4.5.3 Tool motion in offset mode.....	150
4.5.4 Tool motion in offset-cancel mode.....	152
4.6 Comprehensive examples.....	153
4.7 Automatic tool setting gauge.....	156
4.8 Automatic edge finder.....	157
4.9 Instruction of follow-up axis.....	158

Chapter 1 Preface

This system is a universal milling machine, drilling machine, boring machine CNC system which is developed by our company. The control circuit is using the latest industrial high-speed ARM processor, large-scale field and programmable FPGA technology, multi-layer PCB, the machine adopts the high integrated chip and surface mount components, the structure is more compact and reasonable so that make sure the reliability and stability of the system.

Real-time control of high speed (the highest speed shift speeds of up to 30 m / min, the highest feed interpolation speed can reach to 15 m / min), high precision; the use of 800x600 dot matrix TFT LCD adaptive brightness LCD display, LED backlight brightness uniformity and long service life, and overcomes the display brightness by environmental temperature changes the shortcoming. Full screen English menu display, operation is simple and convenient.

This system is based on the milling machine as the representative of the two or three, four axis linkage, This system is based on the lathe as the representative of the two or three, four axis linkage, closed-loop control universal fully digital control system, powerful function and many instructions, programming code accords with ISO international code standard. Direct control of AC servo, choosing the dual channel AC servo driver which is high price ratio.

This manual details the programming and using method of lathe system.

Important Notice:

- 1. All the functions of A axis are effective when configure fourth axis system.**
- 2. When use this system for the first time, please read carefully all the details of each chapter so as to make it work more efficiently.**
- 3. The “Run” button on the panel of system can be used when debugging (No.9 parameter in other parameter to set “Effective” “Invalid”), must plus an external “Run” button when fitting system, otherwise may cause accident because of the life of button!!!So the system prohibits using the button for many times, otherwise the consequences has nothing to do with the company**

Chapter 2 Controller installation and connection

2.1 System electrical specification

- 32bits high performance industrial grade ARM+DSP+FPGA
- 128M User storage space
- 800x600 TFT LCD adaptive brightness, LED backlight LCD
- Touch type key board to have excellent operational sensitivity.
- RS232 communication port
- USB port
- Highly anti-interference of switching power supply.
- Two-way spindle to variable frequency and speed control
- Manual pulse generator
- The band switch trim the feeding speed and spindle speed

2.2 System technical index

- Controllable axis: X Y Z A four axis
- Linkage axis: straight line X Y Z A four axis, arc X Y Z any two axis
- Pulse equivalency: 0.001mm
- Maximum speed: 30000mm/min
- Processing speed: 0.01-15000mm/min
- Minimal input unit: 0.001mm
- Programme size range: ± 99999.999 mm
- Programme coordinate system definition: IOS-841 international standard
- Programme code: IOS-840 international standard
- Mean Time Between Failure (MTBF): Greater than 6000 hours

2.3 Environment of operation

- Power supply: AC 220V (+10%,-15%), frequency 50Hz $\pm 1\%$
- Power source ≤ 100 W
- Running temperature: 5~45°C, relative humidity: 40~80%
- Storage and transportation temperature: 0~55°C, relative humidity less than 90%(40°C)

2.4 System installation and connection

At first, users should check whether the hardware is complete, unwounded and compatible, such as: CNC system, driving power, servo motor, photoelectric encoder, electric tool carrier.

The installation of CNC system must be fastened tightly, with some spaces

around to ensure the ventilation of air. Panel should be put in a place where it is not only convenient to operate and but also able to avoid hurt of heating by scrap iron.

Intense current, week current must be put separately; CNC system and driver should be possibly away from the machine intense current. In order to reduce interference, all signal cables should be kept away from AC contactor. Photoelectric encoder, limit, basic point signal are advisably not to be connected directly to CNC system through intense current box. All power cords must be grounding.

Fix all plugs with screw. Forbid to insert and extract all cables when power is on.

In installation of CNC system, panel should avoid hurting by hard and sharp materials. If the painting of other part of machine is needed, please take off CNC system to keep it clean.

To ensure there is no strong magnet and current interference, keep away from inflammable, explosive and other danger materials.

Pay attention:

- 1. Must install in an electricity cabinet which is good for protect from lightning.**
- 2. Must install firmly to in case of vibrating and losing.**
- 3. Don't install on the inflammable things or nearby to keep away from fire.**

2.5 Controller dimension(400x245x120)

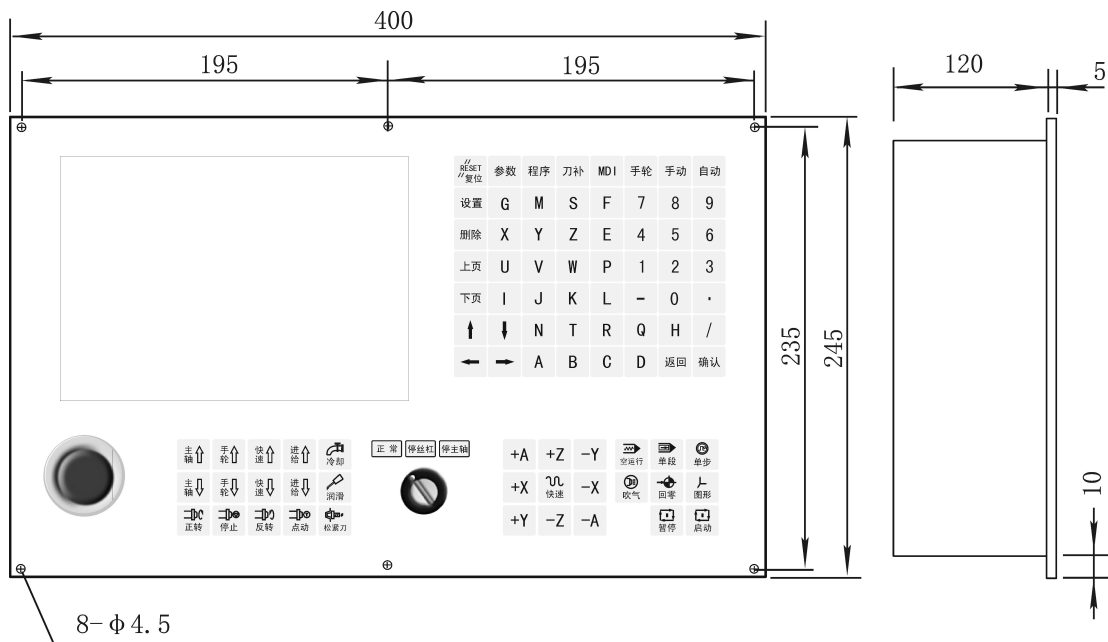

2.6 controller rear view

Pay attention:Switching power supply L N must through isolation transformer and insert to AC 220V, current 0.5A.

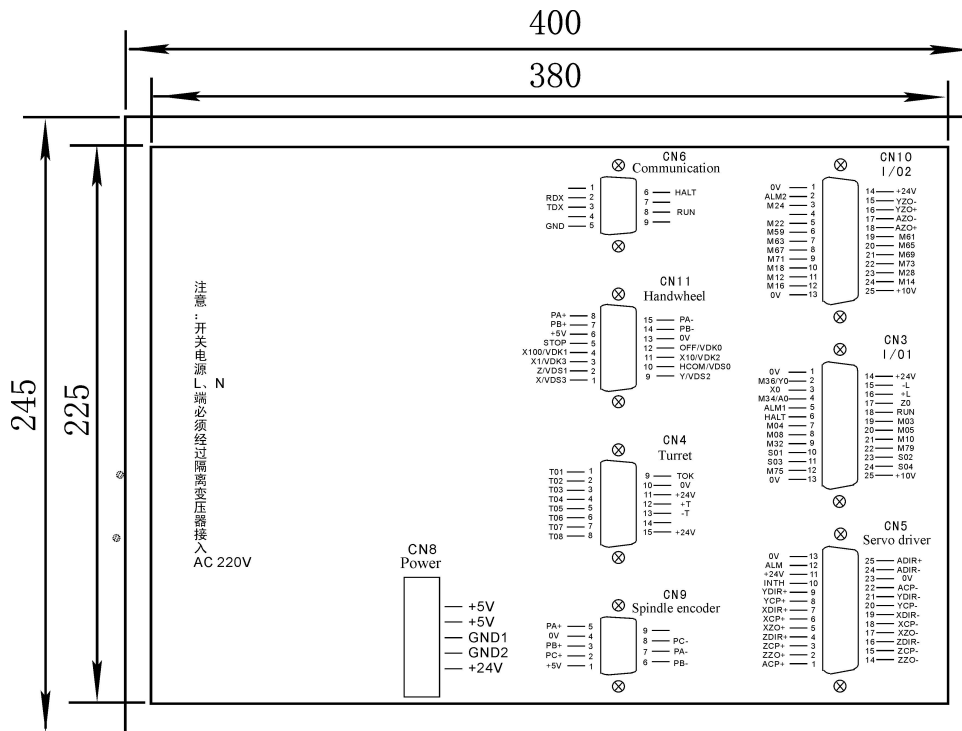

2.7 Interface connection graph

2.7.1 Communication CN6 female socket (DB9)

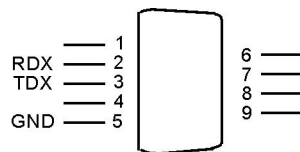

CN6 communication signal with the hole socket DB9				
Signal	Pin	I/O	Function	Effective level
0V	5	OUT	Signal ground	0V
RXD	2	IN	Received data signal	
TXD	3	OUT	Transmission data signal	
+5V	1	OUT	Power supply	+5V
LEDT	4	IN	Interfere left side	0V
HALT	6	IN	Spindle of stop	0V
RIGHT	7	IN	Interfere right side	0V
RUN	8	IN	Spindle of running	0V
STOP	9	IN	Emergency stop signal	0V

Pay attention:

1. Connect to external PC with data communication, must be equipped with our special communication software.
2. Communication line must adopt the shielded twisted pair cable, the length shall not exceed 10m.

The signal of CN6 connection to PC:

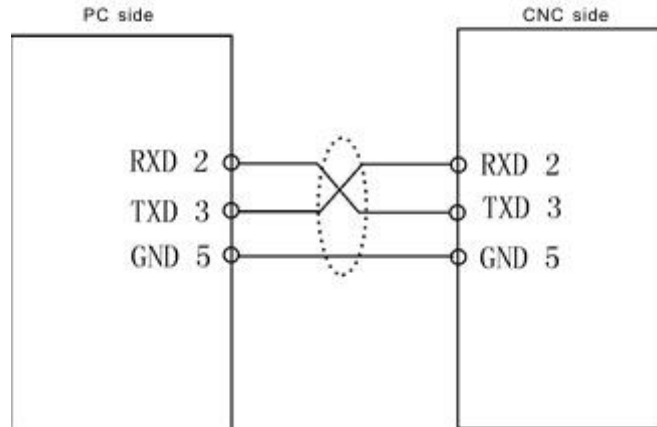

Pay attention: When PC programming, the files should be text files.

2.7.2 IO 1 signal CN3 female socket(DB25)

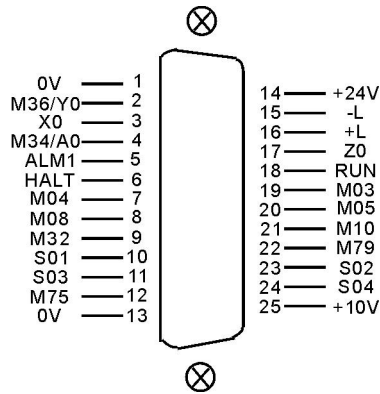

CN3		I/O1 machine signal DB25 female socket		
Signal	Pin	I/O	Function	Effective Level
0V	1	OUT	Power ground	0V
+24V	14	OUT	24V power	+24V
M36/Y0	2	IN	Y axis home signal	0V
X0	3	IN	X axis home signal	0V
Z0	17	IN	Z axis home signal	0V
-L	15	IN	Machine negative limit	0V
+L	16	IN	Machine positive limit	0V
M34/A0	4	IN	A axis home signal	0V
ALM1	5	IN	Spindle alarm	0V
HALT	6	IN	External pause button	0V
RUN	18	IN	External start button	0V
M03	19	OUT	Spindle CW	0V
M04	7	OUT	Spindle CCW	0V
M05	20	OUT	Spindle stop	0V
M08	8	OUT	Coolant	0V
M10	21	OUT	Tool loosen/tighten	0V

M32	9	OUT	Lubricant	0V
M79	22	OUT	User-define output 7	0V
S01	10	OUT	Spindle 1st gear	0V
S02	23	OUT	Spindle 2nd gear	0V
S03	11	OUT	Spindle 3rd gear	0V
S04	24	OUT	Spindle 4th gear	0V
M75	12	OUT	User-define output 8	0V
+10V	25	OUT	1st analog output	0~10V
0V	13	OUT	Analog ground	0V

2.7.3 IO 2 signal CN10 female socket(DB25)

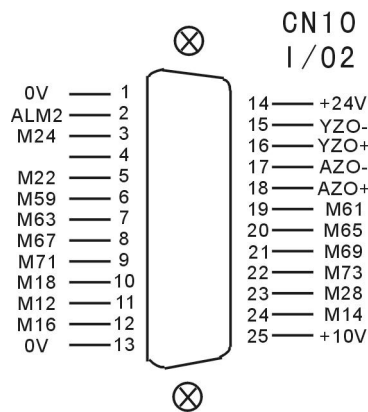

Signal	Pin	I/O	Function	Effective Level
0V	1	OUT	Power ground	0V
+24V	14	OUT	24V power	+24V
ALM2	2	IN	Lubricant alarm	0V
M24	3	IN	User-define input 7	0V
M22	5	IN	M01 conditional pause	0V
M59	6	OUT	Huff output	0V
M61	19	OUT	User-define output 1	0V
M63	7	OUT	User-define output 2	0V
M65	20	OUT	User-define output 3	0V
M67	8	OUT	User-define output 4	0V
M69	21	OUT	User-define output 5	0V
M71	9	OUT	User-define output 6	0V
M73	22	OUT	User-define output 7	0V
M18	10	IN	User-define input 1	0V
M28	23	IN	User-define input 2	0V
M12	11	IN	User-define input 3	0V
M14	24	IN	User-define input 4	0V
M16	12	IN	User-define input 5	0V
YZO+	16	IN	Y axis motor zero+	5V
YZO-	15	IN	Y axis motor zero-	

AZO+	18	IN	A axis motor zero+	5V
AZO-	17	IN	A axis motor zero-	
+10V	25	OUT	2nd analog output	0~10V
0V	13	OUT	Analog ground	0V

2.7.4 Servo driver signal CN5 male socket(DB25)

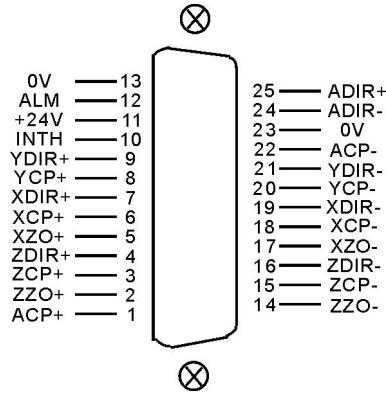

CN5 Servo driver signal DB25male socket				
Signal	Pin	I/O	Function	Effective Level
XCP+/-	6/18	OUT	X axis pulse signal	5V
XDIR+/-	7/19	OUT	X axis direction signal	5V
YCP+/-	8/20	OUT	Y axis pulse signal	5V
YDIR+/-	9/21	OUT	Y axis direction signal	5V
XZO+/-	5/17	IN	X axis motor zero	5V
ZCP+/-	3/15	OUT	Z axis pulse signal	5V
ZDIR+/-	4/16	OUT	Z axis direction signal	5V
ZZO+/-	2/14	IN	Z axis motor zero	5V
ACP+/-	1/22	OUT	A axis pulse signal	5V
ADIR+/-	25/24	OUT	A axis direction signal	5V
ALM/0V	12/13	OUT	Servo alarm/0V	0V
+24V/0V	11/23	OUT	+24V power	24V
INTH	10	OUT	Servo alarm reset	0V

Attention:

1. driver signal cable must be twisted shielded pair, max length is 20m.
2. Serco alarm signal mode(NO/NC) is defined by Other parameter P17.

Servo Alarm signal diagram:

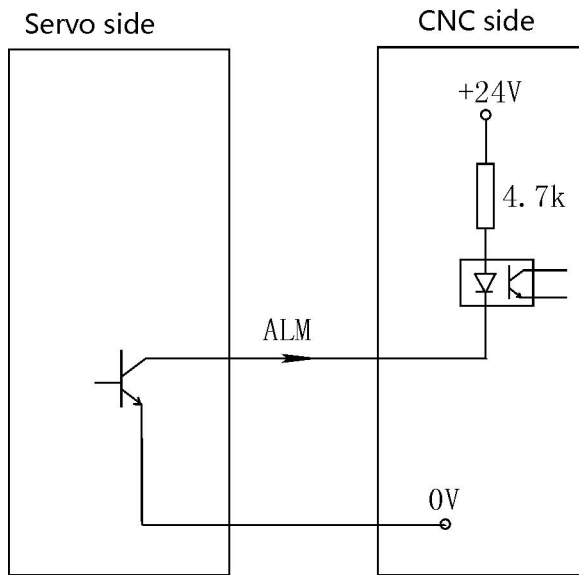

2.7.5 External switch, electrical handwheel CN11 male socket(DB15)

CN11 DB15 I/O signal				
Signal	Pin	I/O	Function	Effective level
0V	13	OUT	Power ground	0V
+5V	6	OUT	5V power supply	+5V
PA+	8	IN	A signal+	5V
PA-	15	IN	A signal-	
PB+	7	IN	B signal+	5V
PB-	14	IN	B signal-	
STOP	5	IN	External emergency stop	0V
OFF/VDK0	12	IN	Off signal	0V
H_X100/VDK1	4	IN	*100 gear	0V
H_X10/VDK2	11	IN	*10 gear	0V
H_X1/VDK3	3	IN	*1 gear	0V
HCOM/VDS0	10	IN	Signal ground	0V
H_Z/VDS1	2	IN	Z axis selection	0V
H_Y/VDS2	9	IN	Y axis selection	0V
H_X/VDS3	1	IN	X axis selection	0V

Pay attention: The inner power supply are all +5V of all signal, do not access voltage higher than 5V.

2.7.5.1 Usage of electrical handwheel(Manual pulse generator)

You can connect standard external handwheel when Other parameter P1=1 and can not use band switch to adjust spindle, feed and external stop running button,so Axis parameter P1, P2 only set to be “0”

PA+ PB- PA+ PA- corresponding input signal of handwheel pulse A B.

Handwheel contact diagrammatic as:

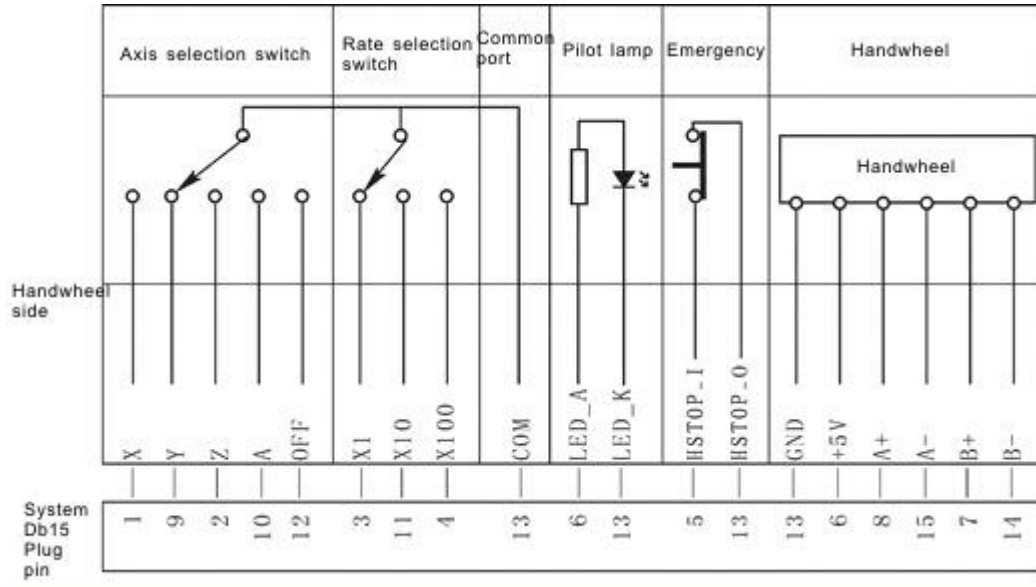

Pay attention:

1. The output signal of handwheel adopts line output, the power supply is +5V.
2. Just connect PA+ PB+ if adopt voltage output.
3. Manual pulse generator needn't "Enter" button, if there is a "Enter" button, use the line to short the ends of switch.
4. The inner power supply are all +5V of all signal, do not access voltage higher than 5V.

The input signal of handwheel:

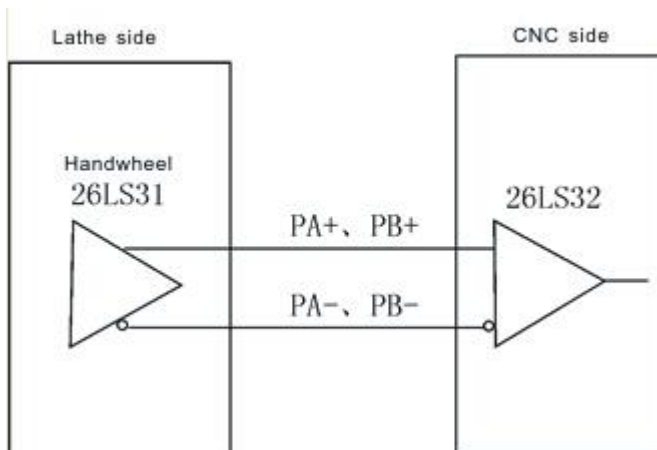

2.7.5.2 Usage of terminal band switch

Could use the band switch when the No.1 No.2 parameter in "axis parameter" are set to 1, the No.1 parameter in "other parameter" should be set to 0, A、Z、Y、X、OFF、X100、X10 and X1 are corresponding to select the feeding axis and the gear of the spindle.

VDS0 (A), VDS1 (Z), VDS2 (Y), VDS3 (X) are input signal which is for trimming gear of spindle speed, four position control, total 16 gears. VDK0 (OFF), VDK1 (X100), VDK2 (X10), VDK3 (X1) are input signal which is for trimming gear of feeding speed, four position control, total 16 gears.

2.7.5.3 Using of external emergency stop

STOP signal is the input signal of external emergency button, Other parameter P27 controls the emergency button is normal open or normal close.

2.7.6 Spindle encoder CN9 male socket(DB9)

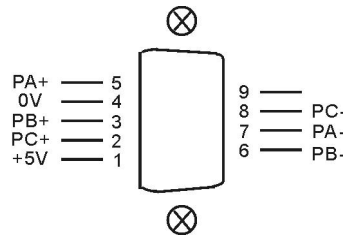

CN9 DB9(pin) spindle encoder				
signal	pin	I/O	function	Effective level
0V	4	OUT	0V	0V
+5V	1	OUT	+5V	+5V
PA+	5	IN	A+ signal	5V
PA-	7	IN	A- signal	
PB+	3	IN	B+ signal	5V
PB-	6	IN	B- signal	
PC+	2	IN	Z+ signal	5V
PC-	8	IN	Z- signal	

Pay attention:

1. The output signal of encoder should be long line output, power supply is +5V.

2. The cable must be shielded twisted pair, the length is 20m at most.

The input signal of encoder PA PB PC:

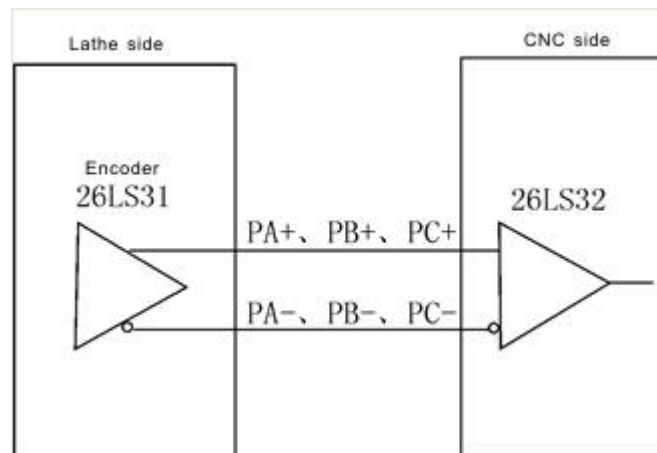

2.7.7 Position feedback signal CN13 male socket(DB26)

CN13 Position feedback encoder/linear scale signal DB26male socket				
Signal	Pin	I/O	Function	Effective level
+5V/0V	9/10	OUT	+5V/0V	
+24V/0V	26/23	OUT	+24V/0V	
DX+/DX-	25/24		RS485+/RS485-	
XA+/-	18/8	IN	X axis A signal	5V

XB+/-	17/7	IN	X axis B signal	5V
YA+/-	14/4	IN	Y axis A signal	5V
YB+/-	13/3	IN	Y axis B signal	5V
ZA+/-	16/6	IN	Z axis A signal	5V
ZB+/-	15/5	IN	Z axis B signal	5V
AA+/-	12/2	IN	A axis A signal	5V
AB+/-	11/1	IN	A axis B signal	5V
BA+/-	22/21	IN	B axis A signal	5V
BB+/-	20/19	IN	B axis B signal	5V

Other parameter P200-P220 are used to set this function. Press G in diagnosis interface to clear order position and feedback position, then reset over tolerance alarm.

Note:

1. encoder or linear scale output signal is long-cable output, power is +5V.
2. signal cable should be twisted shielded pair, no longer than 20m.
3. this is optional function

2.7.8 Parameter setting with absolute motor

1. Turn on the power supply.
2. Set the axis parameter in system to trim motor mode of XYZA axis.
3. Set the axis parameter in system to trim the electrical gear.
Axis parameter P23=10*reduction ratio; X axis numerator
Axis parameter P24=ball screw pitch; X axis denominator
Axis parameter P13=00000001 soft limit effectively;
Axis parameter P33=11111011; Home point with floating mode;
4. Set the other parameter in system
P300=01111100; the absolute value function;
P301=92; P302=91; P303=90;
P304/P305/P306/P307=131072;
P309/P310/P311/P312 set the coordinate values, such as when the screw pitch with direct of Z axis is 6mm,
P311=6000000;
5. Set the coordinate axis which corresponds the No.56 parameter in driver parameter(NEWKer driver)
P1=1, enter the password;
P56=1/2/3/4 corresponds to the X/Y/Z/A, such as the Z axis drive is set to 3;
Press "Enter" for a while to save parameter in EP-status;
6. MDI to run the M500 instruction, the small circle in front of the coordinate axis should be changed into "green", means read the absolute encoder data correctly;
7. Set the coordinate value and direction of lathe:
 - 1) manual move coordinate and remember the lathe coordinate value;
 - 2) MDI to run M501/M502/M503/M504(corresponds to the X/Y/Z/A axis) instruction, reading whether the absolute value coordinate is the same as previous coordinate value or not, modifying the symbol of No.309 No.310 No.311 No.312

parameter in other parameter, such as the X coordinate is not right, the original is P309=4000000, to modify to P309=-4000000;

3) Repeat 1) 2) test for two times;

8. Setting the zero point of lathe: manually move to the position which is nearby the zero point , set the No.314 No.315 No.316 No.317 No.318 parameter in other parameter(Corresponds to X/Y/Z/A/B axis), press "Enter" and press "E" to clear the lathe coordinate;

9. Manual move every axis to the limit position of lathe to set the soft limit value in axis parameter;

10. Set the No.41 parameter in other parameter and back up the current system parameter

2.8 Installation of machine electronic parts .

2.8.1 Limit position: take X Y Z A axis limit position+ as example

Model 1: NPN approach switch

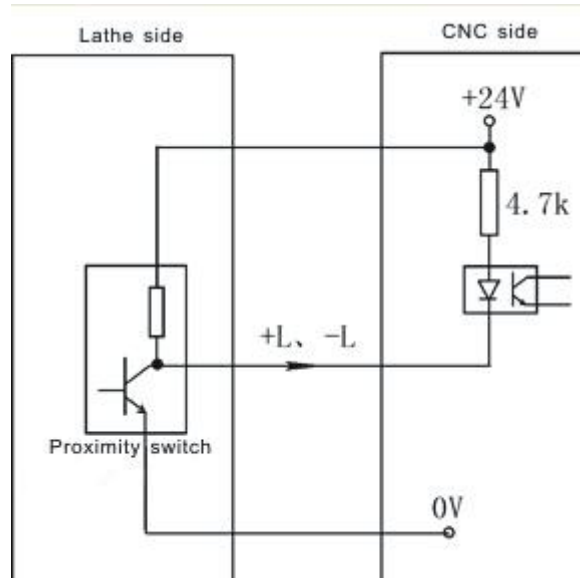

Mode 2: General switch

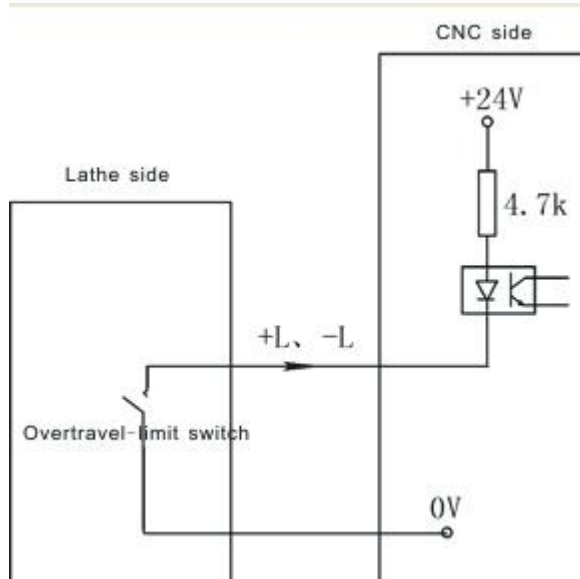

Axis parameter:

No.27 parameter is for setting the type of hard limit switch for +L positive, 0 means always open, 1 means always close.

No.28 parameter is for setting the type of hard limit switch for -L negative, 0 means always open, 1 means always close.

Pay attention:

1. X Y Z A axis limit shares a signal (NC or NO) together, positive limited and negative limited corresponding stand for +L and -L signal.

2. Could select our electrical appliance plate of lathe.

3. The system could define X0 Y0 Z0 A0 to be limited input signal of X Y Z A axis. X0 signal as the limited signal and home point of X axis, the same switch to control. Y0 signal as the limited signal and home point of Y axis, the same switch to control. Z0 signal as the limited signal and home point of Z axis, the same switch to control. A0 signal as the limited signal and home point of A axis, the same switch to control.

The function must copy our exclusive PLC software.

4.8.2 Machine home point(reference point or 0 point): take X axis as example (the same as Y Z A axis)

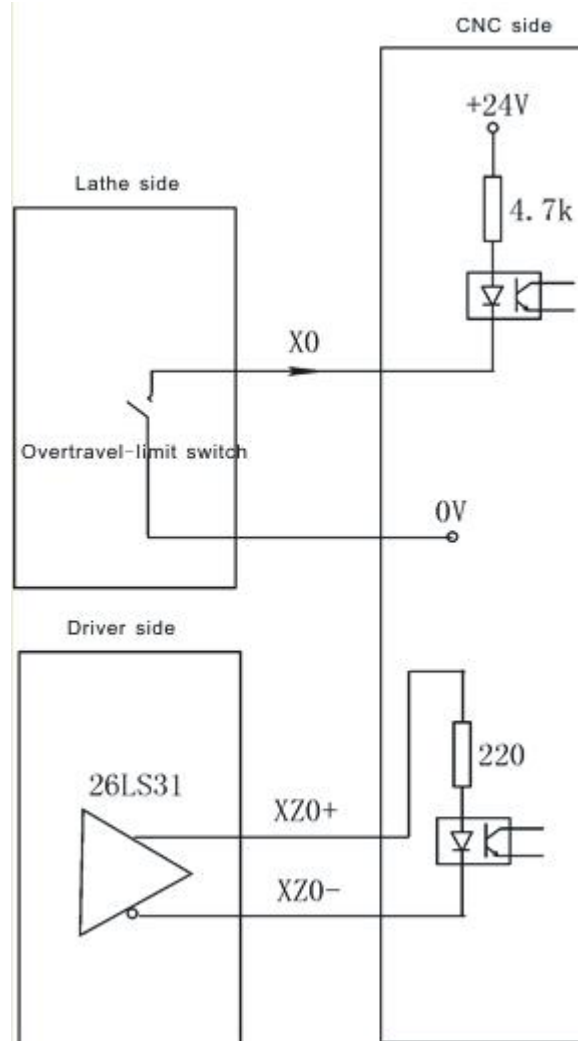

Backing to the home point

At the function of setting floating home point is invalid conditions, backing to the home point need to check approach switch signal and motor Z pulse signal. No.33 parameter in axis parameter is set to be “00000000”.

No.38 parameter in axis parameter set the function of backing to the home points:

There are four ways for system to set backing to the home point when turn on the system:

Needn't when it is 1: system doesn't prompt and no limits when turn on the system every time.

Prompting way when it is 0: system popup a dialog box to prompt user to process operation of backing to the home point, it has no limits.

Forcing mode when it is 8: system popup a dialog box to prompt user to process operation of backing to the home point and not to process before running automatically, the system will import “Feeding axis doesn't back to the home point” and not to process program.

Super forcing mode when it is 9: moving the feeding axis when turn on system every time, the system will popup a dialog box to process operation of backing to the home point, it will prompt “Feeding axis doesn't back to the home point” and not to

process action if not to process operation of backing to the home point.

No.39 parameter in axis parameter set the checking signal mode of backing to the home point:

When it is 0: After hitting the home point switch when backing to the home point, run reverse to check the switch off and check 0 pulse signal of motor encoder.

When it is 1: After hitting the home point switch when backing to the home point, run reverse to check the switch off.

When it is 2: After hitting the home point switch when backing to the home point, continue running to check the switch off and check 0 pulse signal of motor encoder.

When it is residual value: After hitting the home point switch when backing to the home point, continue running to check the switch off.

The mode of backing the home point should according to the circuit situation of equipment, at common conditions, it suggests to set to be 0 or 2, because if not to check 0 pulse signal of motor encoder, the accuracy can't be promise.

No.40 parameter in axis parameter set the direction and sequence of backing to the home point:

Every axis is to set separately. The parameter is positional parameter, D2 controls the processing direction of X axis, D3 controls the direction of backing to zero point in Y axis, D4 is for direction of Z axis, 1 means negative, 0 means positive;

No.41 parameter in axis parameter set the type of home point switch:

Every axis is to set separately. The parameter is positional parameter, D0 position controls X axis, D1 position controls Y axis, D2 position controls Z axis, 1 means always close, 0 means always open.

No.42~No.45 parameter in axis parameter is set to check the processing length of motor Z pulse when backing to the home point:

To set the scope of checking the motor encoder zero pulse signal after switch off when X(No.42) Y(No.43) Z(No.44) A(No.45) axis backing to the home point. Unit: 0.1mm.

Pay attention: The parameter value must less than the distance of motor turns a round, otherwise could cause the wrong home point situation.

No.34 No.36 No.38 No.40 parameter in speed parameter set the speed of reaching to zero point switch when backing to home point (zero point):

The processing speed of reaching to home point switch when X(No.34) Y(No.36) Z(No.38) A(No.40) axis backing to positive home point. Unit: mm/min. Numerical range: Less than the G00 speed of X axis.

No.35 No.37 No.39 No.41 parameter in speed parameter is set to check the processing speed of motor Z pulse when backing to the home point:

When the X (P35) Y (P37) Z (P39) A (P41) axis backing to the home point, the speed of checking the motor Z pulse signal after disengaging the switch for home point. Numerical range: 20-500.

Pay attention: The parameter value influence with the accuracy of backing to the home point, the smaller the value the higher the accuracy. This value has been set which not to change anymore, otherwise it will affect the reference point too.

No.46~No.49 parameter in axis parameter set the offset of finishing back to the home point:

Used to set how much distance to offset before returning to the reference point when the X(No.46) Y(No.47) Z(No.48) A(No.49) axis backing to zero and checking the zero pulse signal of servo motor. Unit: 0.01mm. Numerical range:-99999~+99999.

The parameter value is related to the install position of lathe’s home point and the lathe’s coordinate.

Pay attention: After backing to the home point, the offset speed is determined by G00.

1. The speed reduce switch is also can use NPN switch.
2. Must consider the length of speed reduce when installing the speed reduce switch. Must be less than or equal to 25mm.

2.8.3 Switch signal control: M03 as example (the same as M04 M05 M08 M10 M32 M79 M75 M59 M61 M63 M65 M67 M69 M71 M73 S01—S04)

M03 signal control:

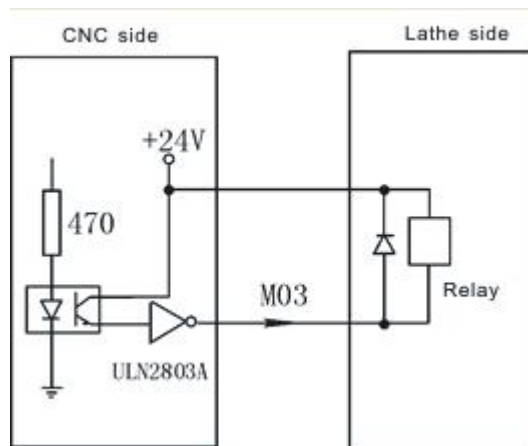

As the picture say, it will form a return circuit with 24V when system outputting M03, The intermediate relay is working and a group of normally open contact form a circuit with spindle rotation AC contactor.

All the low level 0V of output signal is effective.

Pay attention:

1. When the relays and others load, must connected with the diode to absorb the reverse current so as not to damage the system, if use the electromagnetic contactor, then plus resistive and capacitive spark circuit.
2. Chip ULN2803A corresponds output ports:
 - 1). U28 corresponds to M59 M61 M63 M65 M67 M69 M71 M73
 - 2). U29 corresponds to M03 M04 M05 M08 M10 M79 M32 M75
 - 3). U30 corresponds to +T -T S01 S02 S03 S04 LRUN INTH
3. When user-defined signal M71/M70 is used for input signal of spindle chuck and thumbstall, it can't be the other user-defined. No.20 No.21 parameter in other parameter to set.

4. When user-defined signal M65 M67 M69 is used for input signal of “Emergency”, it can’t be the other user-defined. M65 the program stops to output,M69 the program runs output,M67 the alarm output. No.28 No.29 parameter in other parameter to set.

2.8.3.1 Spindle control (M03/M04/M05)

System output two spindles (First spindle, second spindle) controlling signal, relative parameter as follows:

Axis parameter

No.9 parameter: Set the braking time of spindle, also the it’s the output of the hold time, the time less the brake fast.Unit:10ms.

No.10 parameter: Set the braking signal is long signal 1 or short signal 0.

No.43 parameter: Whether turn on the spindle or not when spindle shifting [1 means on, 0 means off]

No.44 parameter: The turning speed of motor when spindle shifting (1/100rpm)

No.45 parameter: The turning direction when spindle shifting (0 means positive, 1 means negative)

No.46 parameter: The stopping time when spindle shifting (10ms)

No.47 parameter: Turning time of low speed when spindle shifting (10ms)

No.48 parameter: Stopping delay time of spindle (10ms)

Speed parameter

No.9 parameter: To set the speed of spindle setting value at manual condition. Unit: rpm.

No.42 parameter: To set the highest speed of spindle, that’s the turning speed of corresponding 10V instruction voltage.

No.43 parameter: To set the highest speed of spindle low gear(second gear) or the highest speed of second spindle, that’s the turning speed of corresponding 10V instruction voltage. Unit: r/min

No.44 parameter: To set the highest speed of spindle (Third gear), that’s the turning speed of corresponding 10V instruction voltage. Unit: r/min

No.45 parameter: To set the highest speed of spindle (Fourth gear), that’s the turning speed of corresponding 10V instruction voltage. Unit: r/min

No.46 parameter: To set the highest speed of second spindle, that’s the turning speed of corresponding 10V instruction voltage. Unit: r/min

2.8.3.2 System lubrication control (M32/M33)

No.4 parameter in other parameter controls the function of lubricate automatically. No.6 parameter set the spacing time of lubrication (Unit: S); No.5 parameter in other parameter set the lubrication time (Unit: S).

Pay attention: The signal is controlled by M32 output.

Other parameter:

No.13 parameter: To set whether spindle and chuck is interlocking or not: 0 means they are separately; 1 means the spindle only start turning when chuck on. The thumbstall can’t be use when the spindle is turning.

Setting parameter is related with the configuration of lathe and user's service condition, but consider for safe, suggest setting 1.

No.20 parameter: To set system controls chuck only need one signal (one-way valve) or two signals (two-way valve), this parameter is related with equipment of lathe.

M10 is just a output signal to control tautness of chuck when set to 0, system carry out chuck to tighten when M10 is effective, loosen chuck when M10 is invalid;

M10 and M71 corresponding control loose and tight of chuck when set to 1, system carry out chuck to tighten when relay M10 is effective, M71 is invalid, loosen chuck when M10 is invalid and M71 is effective. Output M10 when M10, output M71 when M11.

No.22 parameter: To set external button to control loose and tight of chuck(or foot switch), the signal is reciprocating, it means loosen once and then tighten once, reciprocating mode. No external button when set to 0; There is an external button to control chuck when set to 1, the signal is M16.

No.24 parameter: To set the retention time when the output signal M10 M71 of chuck is short signal, set to 0 means the signal is long signal. Unit: S.

Pay attention: M16 is a multiple function signal, only choose one function to use.

2.8.4 System alarm signal: ALM, ALM1, ALM2, Door alarm M12 and

Emergency

No.7 parameter: To set the system whether to check the switching signal of protective door, no door switch when set to 0, there is a switch to control protective door when set to 1; Suggest to set 1 for safe.

No.8 parameter: To set the type of door switch, 0 means always open, 1 means always close.

No.17 parameter: To set the type of system checking the servo alarm signal (twelfth pin of CN5 ALM), 0 means always open, 1 means always close.

No.18 parameter: To set the type of system checking the spindle alarm signal of lathe (fifth pin of CN3 ALM1), 0 means always open, 1 means always close.

No.19 parameter: To set the type of system checking the alarm signal of lathe (second pin of CN19 ALM2), 0 means always open, 1 means always close.

No.27 parameter: To set the Emergency always open or close of system CN11, suggest setting always close for safe.

Emergency STOP: Press “Emergency” when appearing emergent accident, the lathe will stop all actions and the screen of system shows “Emergency”. Wait for pressing up the button. Output M67 signal is effective (output alarm) when No.29 parameter in other parameter is effective. This output signal can be used to protect the lathe (Cut off power supply).

No.29 parameter in other parameter is effective when appearing alarm, the output signal M67 is effective.

4.8.5 User-defined output signal M12 (M14 M16 M18 M28 M22 M24,M24, external “Run”, external suspend “HALT”, external “STOP” as the same)

M12 switch use overtravel-limit switch connection as following:

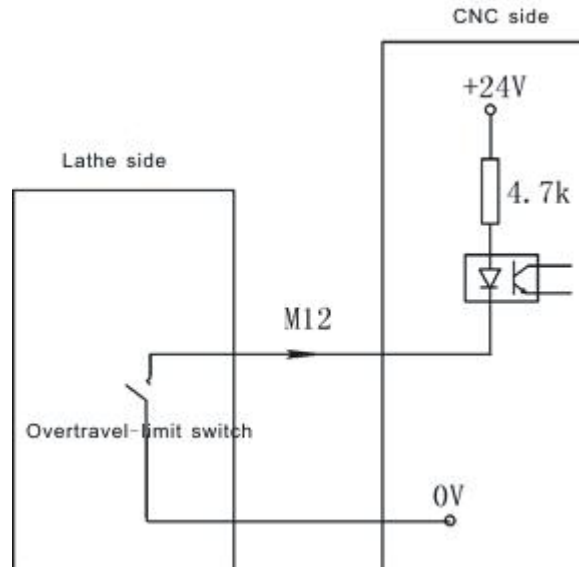

M12 switch also can use NPN as checking switch:

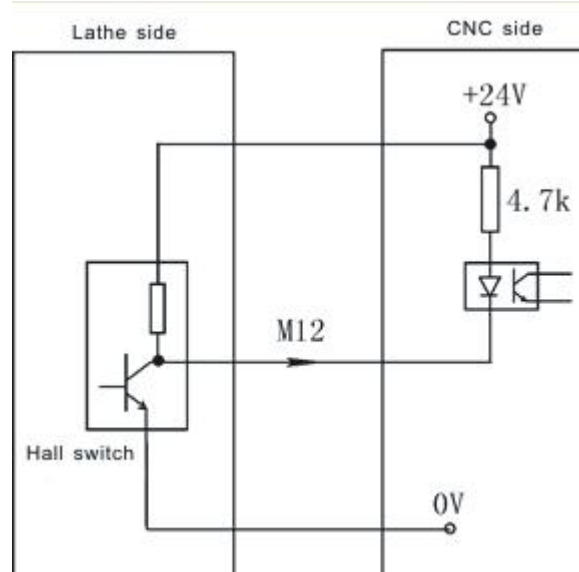

2.9 Electrical element control board(optional)

Our company produces the electrical appliance plate of lathe to choose as follows.

I/O1 socket and CN3 are corresponding one-to-one with CN3 pins of system;

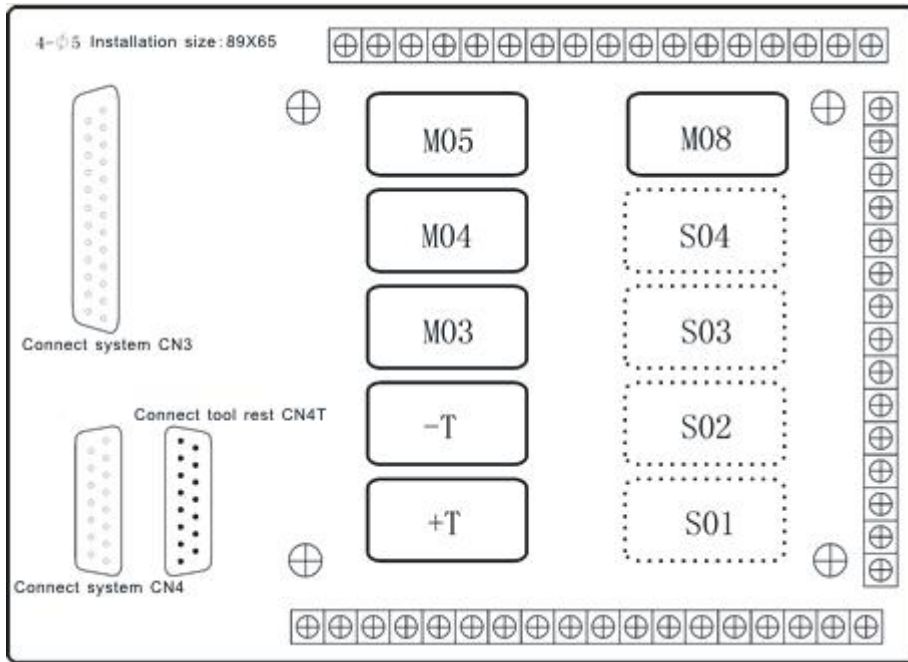

2.9.1 Spindle control

C1 is the common port of M03 and M04.

C2 is the common port of M05, M5B is always close.

2.9.2 Spindle gear control

C4 is the common port of S1 and S2, S1B and S2B are always close.

C5 is the common port of S3 and S4, S3B and S4B are always close.

2.10 Relay board(optional)

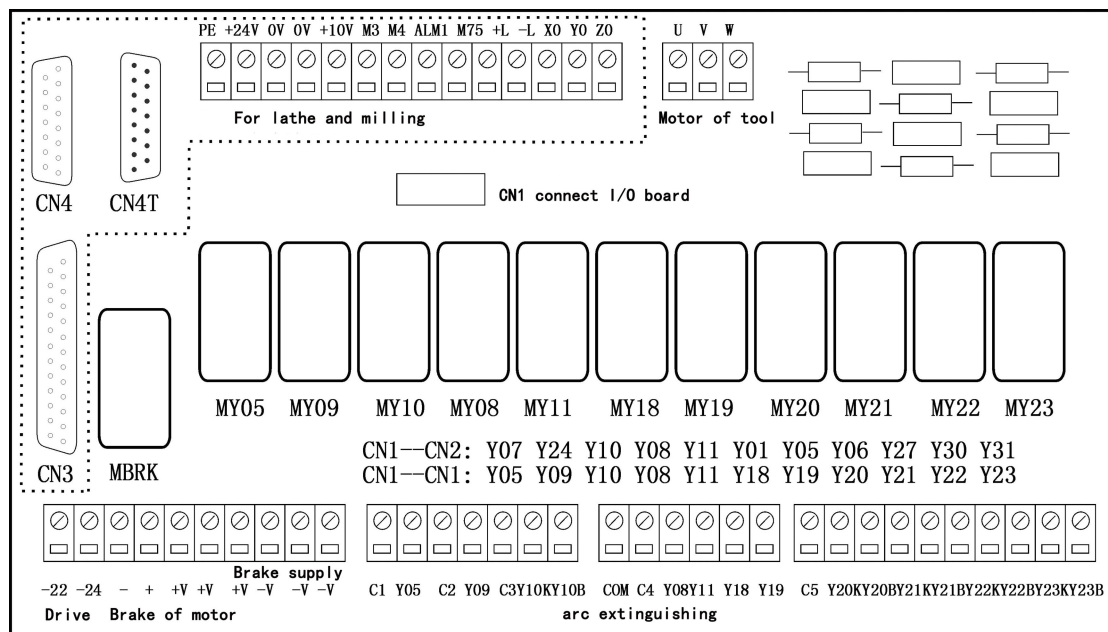

There is a relay board produce by our company for your option:

1. CN1 connects to I/O board, 1 to 11 pins control relays;

Y05,Y09,Y10,Y08,Y11,Y18,Y19,Y20,Y21,Y22,Y23 correspond:

M71,M79,M10,M32,M08,+T, -T, S04,S03,S02,S01.

2. _22 connects to CN3-22 pin of driver, _24 connects to CN3-24 pin of driver;
3. -,+ connect to motor with brake;
4. -V,+V connect with brake supply;
5. PE terminal must be connected to grounding bar of machine in case of interference;
6. Dotted box is applied to servo type controller: CN3,CN4 connect with CN3,CN4 of controller, CN4T connects to electrical turret signal socket, R21-R24 connect to pull-up resistor of electrical turret signal T1-T4.

Chapter 3 Operation

3.1 Summary

When using this CNC system, as long as the master of the system parameters, the program edit, manual operation, automatically running, it can be very convenient to operate.

3.2 Operation panel

This system panel is composed of the main panel and side sub-panel. The main panel is used for parameter setting and program editing and the sub-panel is for tool setting and processing operations.

3.3 Keyboard description

3.3.1 Rate increase or decrease

(1) **Rapid override(G)** 

There are six gears in rapid override form 5% to 100%, by adjusting the key of rapid override is for the following instruction: G00,G26,G28,G611,G613, rapid feed fixed cycle, rapid manual feed.

(2) **Feed override(F)** 

There are sixteen gears in feed override from 0% to 150%, by adjusting the key of feed override is for the following instruction:G01,G02,G03, the feed override of the fixed cycle and manual run effectively.

(3) **Spindle override(S)** 





There are sixteen gears in spindle override from 5% to 150%, by adjusting the key of spindle override is for the speed of the first spindle.



















3.3.2 Usage for intervention switch

It is used to start the execution of processing program.

3.3.3 Others keys

Keyboards	Functions
Letter key	ABCDEFGHIJKLMNOPQRSTUVWXYZ123456789
Number key	.-: for program instructions, parameters' edition; number keys are used for inputting data and selecting sub-menu.

Edit key	“↑、↓、→、←、Del、PgUp、PgDn”for programming, direction keys can be used for selecting menu.
+X,-X +Y,-Y +Z,-Z +A,-A	It is used to feed manually.
Function key	<p>“Esc” returning to upper level or stop a operation “Enter” selecting sub-menu and changing a newline “Del” delete program “program”entering program edition “parameter” entering parameter setting “diagnosis” entering diagnosis I/o function “manual” entering manual status “handwheel” for starting or stopping handwheel function “Tool” for confirming current tool ‘s position in machine tool coordinates system. “Redeem” for amending tool change errors “Auto” entering automatic status “MDI” entering MDI function</p> <p>“”selecting auto-coordinates/diagram machining</p> <p>“”for single segment or constant work</p> <p>“” for coordinates mode or diagram mode speedy simulating</p> <p>“”for manual increment or manual continuous</p>

Control key	<p>“     ”spindle cw, ccw rotation</p> <p>“  ” coolant on/off</p> <p>“  ”for the shift between electric tool carrier and gang tool carrier</p> <p>“  ” for the shift between hand-driven continuous high speed and low speed.</p> <p>“  ” all axes return to home point</p> <p>“  ” for spindle chuck on/off</p> <p>“  ” for thumbstall on/off</p> <p>“  ”handwheel gear selection</p> <p>“  ” adjusting spindle speed</p> <p>“  ”adjusting feed speed</p> <p>“  ”adjusting G00 speed</p>	
Feed key	<p>    +Y +A-Y -A</p>	For X、Y、Z 、A axes direction feed

3.4 Manual operation

The system adjusts one-level menu operation, intuitive, convenient, shortcut, prompt comprehensive information.

Powering the system is to enter the main interface

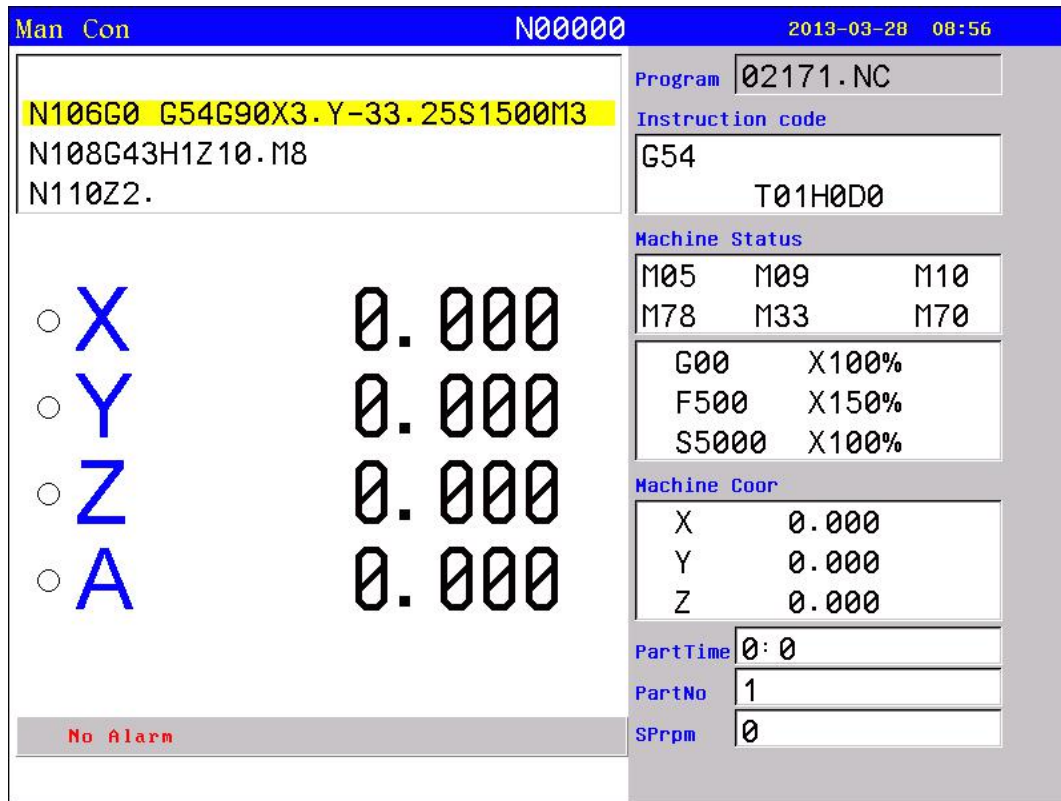

3.4.1 Manual button operation

(1) “F”: Taking mm/min as the unit to set the manual feed speed, the input range is from 1 to 30000mm/min. And the input method according to data input method in parameter.

(2) “”: Switching cycle from “manual continuous” to “manual increment”

(3) “S”: Set the speed of the first spindle. The range is from 0 to 99999, the max depends on the No.36 parameter in speed parameter.

(4) “I”: Modify the increment in manual increment

(5) “”: Press once to increase or decrease 10% feed speed when the No.1 axis parameter is 0, the range is from 0% to 150%,16 gears totally.

(6) “”: Press once to increase or decrease G00 or manual rapid override 20%.The range is from 5% to 100%,16 gears totally.

(7) “”: Press once to increase or decrease the spindle override 10% when the No.2 parameter in axis parameter is 0. The range is form 5% to 150%,16 gears totally.

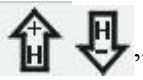



(8) “”: To switch cycle “0.001” “0.01” “0.1” or “0.1” “0.01” “0.001” in the handwheel function.

(9) “Diagnosis”: Enter the diagnosis of input or output.

(10)“Setup”: To set a value(G54-G59) in workpiece coordinate(G54-G59);Use “MDI” to set G54-G59 in lathe coordinate(G53).

(11)“Auto”: Select automatic mode.

(12)“Manual”: Select manual mode.

(13)Spindle controlled: “ ||  ||  || ”Controlling spindle on clockwise, counterclockwise, stop, correspond to instructions M03,M04,M05. When No.56 parameter in the axis parameter is “8”then press “spindle on counterclockwise” means counterclockwise inching turning.

(14)“Cooling”: Coolant on or off correspond to instructions M08,M09.

(15)“Chuck”: Chuck tightens or loose correspond to instructions M10,M11.

(16)“Manual speed controlled”: Press “1” “2” “3” “4” “5” “6” “7” “8” “9” to set feed override “F30” “F60” “F120” “F250” “F500” “F1000” “F1500” “F2000” “F2500” “F3000”.

(17) “Tailstock”: Tailstock tighten or loose correspond to instructions M79, M78.

(18) “Switch manual continuous or increment”: Press  to manual continuous or increment, it displays I=XXXX.XXX when it is manual increment.

(19) “Back to home point”: Press  and X or Z, the X or Z axis goes back to the home point automatically; Press “0”X axis firstly and then Z axis; Press “Esc” to cancel the construction. The speed controlled by No.31 No.33 parameter in speed parameter, the direction is determined by No.28 parameter in axis parameter.

(20) “Tool carrier controlled”: Press  to change next tool automatically if it is gang tool carrier; After changing next tool it will be stop if it is electric tool carrier; Which tool has changed is going to be redeem. Press “T” and number to change tool directly

(21) “Coordinates feed”: Press “↑ ↓ ← →”correspond to feed A axis and Z axis’s positive or negative direction.

(22) “Switch speed”: Press  to switch the speed to system speed which is changed by No.1 No.2 parameter in speed parameter when it is in coordinate feed, loosen it that will be the previous speed. If set the speed higher than the speed in parameter, it will be the set speed to feed.

(23) “Switch coordinates’ display”: Press “PgUp” or “PgDn” to switch the display which correspond to “relative” “absolute” “machine”.

(24) “Workpiece number clear”: Press Del and Enter.

(25) “Back to G53 coordinate home point”: Press “Q” and Enter.

(26) “Incremental coordinate”: Press “Setup” to fix or set 0 after select “relative” coordinate.

PS: Lathe coordinate clear: Press “E” in parameter and then press “Enter”.

3.4.2 Manual continuous

Continuous operation is to press the time as the basis, Press to feed, up to stop feeding. Making sure the axis and using “+X、-X、+Y、-Y、+Z、-Z、+A、-A” to feed, the speed of feed is determined by display on the interface(F) times the rate.

When continuous starting, press “” to switch the speed to No.1 No.2 No.3 parameter value in speed parameter. If set the speed higher than the speed in parameter, the feed speed will be No.1 No.2 No.3 parameter in speed parameter times rapid override.



In order to facilitate the user single axis cutting in the manual function, setting the manual speed in manual status. Press “F” and input the speed.

When the hard limit point beyond positive and negative feed running axis two direction at, stop the feed and prompt to feed reverse direction.(the same as hereinafter)

The manual maximum speed is limited by No.4 parameter in speed parameter, when setting the speed is higher than the value of parameter, then will be the No.4 parameter.

When No.38 other parameter is 8, “” is change into a switch, press once to turn on (no more to always press), press again to turn off.

3.4.3 Manual increment

This operation is to set the value of increment as the basis, press “↑ ↓ ← →” once to run a value of increment. It will prompts “I=0010.000” in manual increment represent for the value of increment is 10mm, press “I” to revise and Enter. But also press “handwheel” and “ ”to switch the value into 0.001mm 0.01mm 0.1mm.

The speed is the speed on display(F) times the rate.

3.4.4 Back to machine home point (reference point)

There are two ways to back to home point in this system, not only the switch for home point, but also can set floating point, the methods as follows:

Switch for home point:

Back to home point operation is to feed every axis to lathe’s home point position in turn. When the parameter of feeding axis which back to home point is 0, the axis of coordinate detects the home point and return to the pulsing signal of “Zero”, the data of lathe’s coordinate will be 0 automatically.

Switch on the power supply of the system, release alarm and the button of emergency after the CNC is power off, the need to back to home point to set lathe’s coordinate correctly.

Instruction:

- 1. The system requires for backing to the home point every time when it is power on, the requirement can be set by No.38 parameter in axis parameter, it can be prompt or force;

2. The way and type of detecting signal can be set by No.39 parameter in axis parameter, so detect the switch of home point is effective, also detect the Z pulsing signal of electrical motor after detecting the switch of home point (precision higher), detect forward or reverse for Z pulsing signal of electrical motor.
3. The direction for backing to home point can be set by No.40 parameter in axis parameter, D2 D3 D4 correspond to X Y Z axis, 0 is forward, 1 is reverse.
4. The type of the switch for home point can be set by No.41 parameter in axis parameter, D0 D1 D2 correspond to X Y Z axis, 0 is always on, 1 is always off.
5. The maximum length of detecting Z pulse of electrical motor can be set by No.37 No.38 No.39 parameter in axis parameter, the value must less than the pulse of electrical motor run a cycle.
6. The shifting distance after backing to home point can be set by No.46 No.47 No.48 parameter in axis parameter, rapid move coordinate to the value of parameter after backing to home point.

No switch for home point:

To set floating point to make sure, turn on corresponding function of floating point by No.33 parameter in axis parameter, setting No.34 No.35 No.36 parameter to make sure the floating point of X Y Z axis, the home point of lathe.

The steps to set floating point as follows:

1. Setting the No.33 parameter in axis parameter to enable corresponding floating point. For example: Turn X axis on is “00001000”. (turn all of them on is 00111000.)
2. Moving X axis to designate position so that set floating point.
3. Press “Parameter”, “Axis parameter” and select No.34 parameter, “Enter”, popup a dialog box of X axis’ floating point coordinate. Import the value of setting lathe coordinate.

If it is 0, the lathe coordinate of X axis now is the home point of X axis. The lathe backs to this position every time when backing to the home point.

If it is 15, the current lathe coordinate of X axis is 15.000, the distance to lathe’s home point is 15mm.

The method to set floating point of Y Z axis is the same as the above to set X axis.

Operation for backing to the home point:



At the manual condition, press “” and select X Y Z A axis to back to the home point in dialog box. Or import 0 to make the axis back in order, the cycle will turn to green in front when backing to the home point successfully, defeat otherwise.

If stop in the process, press “Stop” or “Reset” to stop backing to the home point.



Pay attention:

Every time when power on the system, it must back to the home point to make sure the accuracy of lathe process. The system power off unusually or in an accident, it must back to the home point, otherwise could cause error.

3.4.5 Handwheel(MPG)

Two types: hand held and panel, No.1 parameter in other parameter to set.

1.Panel:

Press “handwheel” and “X” “Y” “Z” “A”to select an axis, “ ” to adjust the gear.

2.Hand held:

Press “handwheel” and operate the switch of axis selection to select an axis, operate the axis and switch of handwheel override to adjust the gear.

Instruction

The handwheel is mainly used for “Tool”, the speed and the handwheel feed of one measure is related to rotate the handwheel fast or low. The speed is not too fast best when the system cooperate with stepping motor.

Handwheel’s pulse generator speed to be lower than 200r/min(The handwheel to 100 pulse a cycle), the handwheel’s acceleration is controlled by No.24 parameter in speed parameter(the bigger the faster). The maximum speed is controlled by No.26(X axis) No.27(Y axis) No.28(Z axis) in speed parameter.

Handwheel is invalid in auto-coordinates diagram machining, it only works in working coordinates.

3.4.6 Workpiece coordinate system

1. Press "MDI" button to select the corresponding workpiece coordinate system (G54-G59);
2. Moving the axis which is going to set tool to the specified location;
3. Press "Setup" to import the corresponding coordinate of workpiece coordinate system..

3.5 Auto operation

Auto refers to processing the editing program of workpiece. This system can start at arbitrary point, and also can start at arbitrary line or with arbitrary tool. Starting arbitrary line or with arbitrary tool must use absolute coordinate to edit the program. Auto operation can’t move the manual coordinate.

Running program selection: In the program interface, press “↑ ↓” to move the cursor to a program which is going to be carry out, press “C” to select the program to run automatically.

Press “Auto” to enter automatic mode from manual mode.

Switch display of coordinates: Press “Pgup” “Pgdn” to switch the interface into “absolute coordinate” “relative coordinate” All coordinate”.

3.5.1 Automatical process

“Single or Continuous”: Press “” to switch cycle.

“Continuous”: The program continue to execute every program segment(program line) to end or the instruction of stop to stop.

“Single ”: The program just execute one program line and end, wait another operation or press “Run” again to execute one next program line.

“Coordinate or Figure”: Press “” to switch cycle.

“Automatic coordinate”: The axis of coordinate will display with value.

“Automatically figure”: The axis of coordinate will display with a figure. There are two kinds of figure, horizontal lathe and slant-bed lathe, No.3 parameter in tool parameter to control.

“Automatic idle run ”: The program is speedy simulate, the axis of coordinate can't move.

3.5.2 Processing at arbitrary program line or with arbitrary tool

A. Run at actual line

At the automatical process condition, press “—” to popup a dialog box, import a number of line, press “Enter” to confirm, the line will start from the defined actual line.

Pay attention:

1. The line is the actual line in the program, not the “N” stand for the line. The system process to the line you import with a speed which is set by No.6 parameter in speed parameter(G01/G02/G03), then process the program normally.

2. The line of default is the line of suspend the program last time, to facilitate user's operations.

3. At the interface of coordinate to use “N” to search line and press “Reset” to back to the beginning of program.

B. Run at the marked line

The system has a function to run at the marking line. At automatical process condition, press “N” to prompt a dialog box to import the marking line, press “Enter” to confirm. Press “Run” to process program at the line you import(mark).

Pay attention:

The line is not the actual line, is the “N” stand for the line. The system process to the line you import with a speed which is set by No.6 parameter in speed parameter(G01/G02/G03), then process the program normally.

3.5.3 Start program

Press “Auto” to switch to automatical mode to process program, two methods as follows.

- (1) Press “Run”
- (2) Switch on the Run of external signal.

3.5.4 Stop processing program

Five methods as follows to stop:

- (1) The instruction of program M00 M01 M02 M30 M20.
- (2) Press “” to run a current line and stop.
- (3) Pause switch on the panel.
- (4) Switch on the Halt of external signal.
- (5) Press “Reset” to stop all the actions of program.(Like spindle, tools and others)

3.5.5 Real-time control in automatic process

(1) “”: Press once to increase or decrease 10% feed speed when the No.1

axis parameter is 0, the range is from 0% to 150%,16 gears totally; When the No.1 axis parameter is 1, external band switch takes in control, Adjust the speed of process arbitrarily in the process according to the different situation.

(2) “”: Press once to increase or decrease G00 or manual rapid override 20%.The range is from 5% to 100%,16 gears totally. Adjust the rapid override arbitrarily according to the different situation.

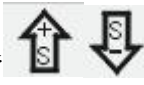
(3) “”: Press once to increase or decrease the spindle override 10% when the No.2 parameter in axis parameter is 0. The range is form 5% to 150%,16 gears totally. When the No.2 axis parameter is 1, external band switch takes in control, Adjust the speed of spindle arbitrarily in the process according to the different situation.

(4) Stop in the process: At the continuous mode in process condition, press “” to stop running after executing a current program line, wait for operating.

(5) Suspend in the process: Turn the intervention switch right or middle and switch on external stop signal of Halt, the processing program will stop; Press “Reset” to exit automatical process mode and the program line is going to back to the first of the processing program.

(6) Keep feeding: When the process is suspending, press “Manual” to keep feeding automatically, also can adjust the coordinate, press “Auto” and “Run” to run to the point of suspend automatically to end.

(7) Exit process: Press “Reset” when processing, suspending or keep feeding.

(8) Enable macro program by input point during processing. For example: if X7 is valid, then run PrgramUser9, and add following PLC:

```

X07  M122
-----| |-----| |------(S)M300      ;if X7 is valid, run M300;
X07  M300 M122
----| |-----| |-----| |------(S)M1014    ;if X7 is valid, reset current program
M300  M122  X07
----| |-----| |-----| |------(S)M1069    ;Enter in manual mode;
M300  M122  M01 X07
--| |-----| |-----| |-----| |------(S)M1079    ;Execute ProgramUser9;
                                     |--(R)M300      ;reset M300

```

M300: intermediate register, the same M300 is prohibit in PLC;

M1014: reset current program;

M1069: manual mode

M1070-M1079: corresponds to ProgramUser0-9.

3.5.6 Operation of MDI

At the manual or automatical coordinate conditions, press “M” to get into the processing mode of MDI. Processing a program line that you import in “MDI”, press “Esc” to give up and exit when importing, press “Run” to carry out the program line that you import.

3.5.7 Operation of Handwheel

Press “Handwheel” at automatical mode, the program of turn handwheel is processing automatically, the speed is related to the speed of “F”, feed override and turn handwheel fast or slow. This mode is for trying to process in running program usually.

Pay attention: The acceleration, deceleration and maximum speed of running handwheel are controlled by No.23-No.29 parameter, use the acquiescent acceleration, deceleration and the speed of G00 when the parameter is set to be invalid.

3.5.8 Function of DNC

The storage space of user is 32Mbit in this system, use DNC to process when the processing program is greater than 32M or the remainder storage space. Switch on RS232 or USB to realize the function of DNC in this system.

A. Instruction for RS232-DNC

1. Use the dedicated communication wire to connect the computer and the system to set the corresponding communication interface and speed by the system.
2. Use the dedicated communication software of this system by computer to set the corresponding communication interface and speed. Press “Send CNC program file”, select the program file to process linked, enter the status of sending program file.
3. To enter the interface of program file in NC system, press "L" to enter the status of linked process, now the upper right corner of the display interface is "RS232--DNC", press “Run” to running carry out linked process in the automatic status.
4. Turn “Intervention switch” to middle or right to stop the running system in the process of linked process, press “Stop” or “Reset” to exit the status of linked process.

Pay attention: 1. The baud rate is related to operational environment when using serial port to send files.

2. The communication cable can't more than 10 meters length.

3. Only the dedicated communication software of this system can send program in user's computer. To set the sending speed of PC as the NC, defeat otherwise.

B. Instruction of USB-DNC

USB-DNC is realized by U-disk, switch on U-disk and system, select program to execute in U-disk.

Press “B” to open U-disk in program interface, select corresponding program to press “C” to execute program, press “Auto” to get into automatical mode and press “Run” to process the program.

Pay attention: 1. Don't unplug U-disk in the process of USB-DNC, defeat processing otherwise.

2. Back to the system program interface from U-disk interface after finish USB-DNC.

3. After selecting the program, it is best to press "P" to compile once to make sure the program is right before executing program of USB-DNC.

3.6 Operate safety, Alarm

3.6.1 Emergency stop



Press “” when emergency accidents happening, the system will stop all the actions of lathe and shows “Emergency stop” on the interface. Wait for the button up. M67 imports effective signal when No.29 parameter in other parameter to be set effectively.



Press “” in the process or running lathe, system coordinate and lathe's position may change, make sure the system coordinate again before processing, it is best to carry out operation of backing to the home point to make coordinate same as the lathe's position.

The button can be external which is controlled by No.27 parameter in other parameter to set it normal open or close.

3.6.2 Reset system

Press “Reset” to stop current operation in anytime when the system is running, especially stop all the actions of lathe(spindle, tools and so on) in automatical or manual mode, but the coordinate won't lose, so needn't to back to the home point.

3.6.3 Alarm

The screen shows error information and twinkles when the lathe has alarm, the program is stop running, the coordinate stop moving, check the reason for alarm and clear troubles to run again. The signal M67 is effective when No.29 parameter in other parameter is “1”.

(1) X、Y、Z、A axis are positive hard limited: X、Y、Z、A axis are in the positive position which is limited .

(2) X、Y、Z、A axis are negative hard limited: X、Y、Z、A axis is in the negative position which is limited .

(3) Spindle and inverter (frequency changer) alarm: The alarm signal of lathe's spindle is effective.(ALM1)

- (4) **No.0 alarm:** The alarm signal of machine’s spindle is effective.(ALM2)
- (5) **X, Y, Z, A axis driver alarm:** The alarm signal of servo drivers is effective. (ALM). Press “B” to import INTH signal to reset the servo drivers in diagnosis mode.
- (6) **No.5 alarm for door switch:** The alarm signal of M12(door switch) is effective.
- (7) **+5V is under voltage:** Supply voltage is low, +5V of the system is low.
- (8) **Emergency stop:** Press the button of emergency stop.

3.7 Parameter operation

At any status conditions, press “parameter” to enter the status to set the parameter. Parameter in this system includes “processing parameter” “speed parameter” “axis parameter” “tool parameter” “other parameter” “coordinate” “password”, 7 kinds totally.

Man Con		N00000		2013-03-28 08:57	
1,Cycle d of G7		5.000		Program 02171.NC	
2,Cycle d of G8		5.000		Instruction code	
17,Running prog		0		G54	
18,Set M20 the		-1		T01H0D0	
19,Set part cou		1		Machine Status	
21,G01/G02/G03		0		M05 M09 M10	
22,G00 line del		0		M78 M33 M70	
200,system prot		1		G00 X100%	
202,ststem inne		1		F500 X150%	
				S5000 X100%	
				Machine Coord	
				X 0.000	
				Y 0.000	
				Z 0.000	
N-User		T-Speed		PartTime 0:0	
R-Axis		Q-Tool		PartNo 1	
A-Other		B-Coor		SPrpm 0	
C-PASSWD		D-CANCEL			
No Alarm					

Press N、T、R、Q、A、B、C correspondingly to corresponding interface after enter the parameter interface, press “↑ ↓” to select the number of parameter and press “Enter” to popup a dialog box to import data and press “Enter” again to fix parameter successfully.

Instruction for parameter as follows:

3.7.1 User parameter (processing)

★ 1,Cycle d of G73 (mm)

Used for setting tool retriev value d of fixed loop G73;

★ 2,Cycle d of G83 (mm)

Used for setting tool retrieve value d of fixed loop G83;

- ★3,Cycle Q-direction of G76G(G17:1 is+X,2 is-X,3 is+Y,4 is-Y)

Offset Q direction of fixed loop G76;

- ★4,Cycle Q-direction of G87 (G17:1 is+X,2 is-X,3 is+Y,4 is-Y)

Offset Q direction of fixed loop G87;

- ★5,Cycle spindle angle of G76G87(0.1degree)

Spindle orientation angle of G76 and G87;

- ★6,Mode of G84G74(0 is High speed to d,8 is to R)

Chips removal mode if G84/G74.

- ★7,Cycle d of G84G74 (mm)

Tool retrieve value d of G84/G74;

- ★17,Running program need Sp run [1 mean Yes,0 mean No]

For interlock between program and spindle, to set if detect rotation of spindle or not while program running.

If set as 1, the spindle needs rotate when program running(Need detect the encoder rotation when it is M03); Set as 0, then no need to detect.

- ★18,Set M20 the time of auto-running

The loop times of M20 in program, infinite loop when it is minus.

- ★21,G01/G02/G03 line delay(ms)[>100]

The delay time between G01/G02/G03, this parameter solves the overcut problem in the corner.

- ★22,G00 line delay(ms)[>100]

- ★23,Handwheel smooth acceleration/deceleration constant[50-100]

The smooth acceleration constant when using handwheel, The range is 50-100, smaller value corresponds the faster acceleration, but more vibration.

- ★33,M03/M04/S detect the spindle speed(0:M69 relay, 8:encoder feedback)

M03/M04/S code detect if spindle speed reach already.

- ★34,The error (RPM) of the spindle speed is detected by the encoder feedback.

The telorance error of spindle speed feedback from encoder.

- ★200,system protect times [\geq 2minutes]

When under main interface and no dialog, and if P18>2 minutes, controller will enter in screen protection, any key to quit.

- ★203,Whether strict inspection G41/G42 (34818:No,6326274:Yes)

The controller inspects overcut of G41/G42 strictly.

★210,Enable graphics display area(8:manual,0:Automatic)

Enable graph displaying.

★211,X axis negative end

X axis negative end of graph displaying;

★212,X axis positive end

X axis positive end of graph displaying;

★213,Y axis negative end

Y axis negative end of graph displaying;

★214,Y axis positive end

Y axis positive end of graph displaying;

★215,Z axis negative end

Z axis negative end of graph displaying;

★216,Z axis positive end

Z axis positive end of graph displaying;

★230,Select executive program through input

(+4...+128,+256...+32768:X26-X31,X16-X23)

Executing program by input points, for example, if P230=+4+8=12, when X26 or X27 is effective to choose the program HIDEFILEX26 or X26 or HIDEFILEX27 or X27.

D2=1, means +4, if X26 is effective, then execute Program X26 or HIDEFILEX26;

D3=1, means +8, if X27 is effective, then execute Program X27 or HIDEFILEX27;

D4=1, means +16, if X28 is effective, then execute Program X28 or HIDEFILEX28;

D5=1, means +32, if X29 is effective, then execute Program X29 or HIDEFILEX29;

D6=1, means +64, if X30 is effective, then execute Program X30 or HIDEFILEX30;

D7=1, means +128, if X31 is effective, then execute Program X31 or HIDEFILEX31;

D8=1, means +256, if X16 is effective, then execute Program X16 or HIDEFILEX16;

D9=1, means +512, if X17 is effective, then execute Program X17 or HIDEFILEX17;

D10=1, means +1024, if X18 is effective, then execute Program X18 or HIDEFILEX18;

D11=1, means +2048, if X19 is effective, then execute Program X19 or HIDEFILEX19;

D12=1, means +4096, if X20 is effective, then execute Program X20 or HIDEFILEX20;

D13=1, means +8192, if X21 is effective, then execute Program X21 or HIDEFILEX21;

D14=1, means +16384, if X22 is effective, then execute Program X22 or HIDEFILEX22;

D15=1, means +32768, if X23 is effective, then execute Program X23 or HIDEFILEX23;

★231,"Delete" mode[0:backward deletion,1:Forward delete]

★232,Check whether the spindle before tapping [18:Yes,0:No]

Check spindle home position before tapping;

★233,G06 Circle teaching function[0:No,1:Yes]

★234,Program back function[+8:Yes]

Use handwheel to run program forward or backward;

★235,Automatically generate comments when teaching [0:Yes,1:No]

★307,M18xx/M28xx/WAT alarm time(ms)[>=10]

The max waiting time for M18xx/M28xx/WAT code, if ove the time, controller will alarm.

★400,Translate DXF file to G code[1:Seqencing,4:Start point seqencing ,8:No seqencing]

1) if P400=1, controller will sequence end to end;

2) if P400=4, controller will sequence end to end, and judging distance between ends to tool start point by parameter, and choose to start tool from nearby end;

3) if P400=8, controller will not sequence. When generate DXF file from AutoCAD, please pay attention to draawing sequence, because DXF file save date according to drawing sequence, the g code generated by controller will also execute according to drawing sequence.

★401,Translate DXF file to G code X-axis coordinate

★Tool start pint X cordinate of DXF file.

★402,Translate DXF file to G code Y-axis coordinate

Tool start pint Y cordinate of DXF file.

★500,G74 equal to ProgramG No.[101-170(101-150Modeless,151-170Mode)]

★501,G81 equal to ProgramG No.[101-170(101-150Modeless,151-170Mode)]

★502,G82 equal to ProgramG No.[101-170(101-150Modeless,151-170Mode)]

★503,G83 equal to ProgramG No.[101-170(101-150Modeless,151-170Mode)]

★504,G84 equal to ProgramG No.[101-170(101-150Modeless,151-170Mode)]

★600,Internal multiplier of non-G0 instruction[>=20 valid]

3.7.2 Speed parameter

★1, X-axis's G00 speed(mm/min)

★2, Y-axis's G00 speed(mm/min)

★3. Z-axis's G00 speed(mm/min)

★4. A-axis's G00 speed(mm/min)

The most speed of G00, the maximum: 30000.

- ★ 5. Manual maximum feed speed(mm/min)
The max speed in manual mode in manual mode.
- ★ 6, Auto Maximum feed speed(mm/min)
The max speed in manual mode in auto mode.
- ★ 7, G01/G02/G03 default speed(mm/min)
When the speed is not defined in the first interpolation command(G01/G02/G03), program will run in the P8 default speed. Maximum: 5000.
- ★ 8, Null run speed(mm/min)
The speed when program does idle/null running. Maximum: 240000.
- ★ 9, Feed axis`s manual speed(mm/min)
The current axis speed in manual mode, range:< P6, unit:mm/min
- ★ 10, Spindle`s manual speed(rpm)
Spindle speed in manual mode.
- ★ 11, Feed axis start speed(mm/min)
Beginning speed when axis starts to move.
- ★ 12, Feed axis maximum mutation speed(mm/min)
- ★ 13, Limit G1G2G3 single axis speed[1 mean Yes,0 mean No]
Set max feed axis speed is limit during interpolation.
- ★ 14, X G1G2G3 max speed(mm/min)
- ★ 15, Y G1G2G3 max speed(mm/min)
- ★ 16. Z G1G2G3 max speed(mm/min)
- ★ 17. A G1G2G3 max speed(mm/min)
XYZA max speed during G1G2G3 interpolation.
- ★ 18, X acceleration/deceleration constant[1~99999]
- ★ 19, Y acceleration/deceleration constant[1~99999]
- ★ 20. Z acceleration/deceleration constant[1~99999]
- ★ 21. A acceleration/deceleration constant[1~99999]
XYZA axis acceleration time constant, the bigger value sets, the faster acceleration is. Range:1-99999.
Note: the value depends on machine configuration, incorrect setting may lead to machine malfunction. Usually, the bigger load, the smaller value. If installed with stepper motor, it can not be over 15000.
- ★ 22, Auto run acceleration/deceleration constant[1-500]
Auto run acceleration constant, rang:1-500. when the valuse is between 1-500, auto run acceleration speed depends on this parameter. Otherwise, refers to axis acceleration speed parameter in user parameter. This parameter is used to extinguish manual and auto acceleration speed, only when the acceleration speed in two mode has big difference, will this parameter work. Normally it is ineffective.
- ★ 23, Handwheel acceleration/deceleration constant[500--30000]

The acceleration speed when use handwheel, range is 500-32000, bigger value means faster acceleration.

★24, Test-run Handwheel acceleration/deceleration constant[>500]

★25, Test-run Handwheel G00 speed(mm/min)[>10]

The idle running speed when use handwheel in auto mode. Ineffective when lower than 10.

★25-1,Auto-run Handwheel G00 start speed(mm/min)[>5]

★26, Handwheel X limit speed(mm/min)

★27, Handwheel Y limit speed(mm/min)

★28, Handwheel Z limit speed(mm/min)

★29, Handwheel A limit speed(mm/min)

Used to set max axis speed when use handwheel, range: 100-max manual speed. The value of P26-P29 depends on machine configuration. It should not be over 4000 in order to run safely. Works only when P26-P29 is bigger than 100.

★30, Acceleration/deceleration type[0 mean line,8 mean curve]

Used to set acceleration type of axis, 8 means acceleration is curve type(S shape), 0 means linear type.

Depending on driver types, usually stepper motor is curve type, servo motor is linear type.

★31, Curve initial acceleration/deceleration constant[>=10]

Initial acceleration constant in curve acceleration type, bigger value means faster acceleration

★32, curve acceleration/deceleration second constant[>=10]

The second acceleration constant in curve acceleration type, bigger value means faster acceleration.

★33, Curve max acceleration/deceleration constant[>=500]

max acceleration constant in curve acceleration type, bigger value means faster acceleration.

★34, X go home positive speed(mm/min)

The speed of X axis going home sensor in forward direction, range: smaller than X G00 speed.

★35, X go home negative speed(mm/min)

The speed of X axis going home sensor in backward direction, range: smaller than X G00 speed.

★36, Y go home positive speed(mm/min)

The speed of Y axis going home sensor in forward direction, range: smaller than Y G00 speed.

★37, Y go home negative speed(mm/min)

The speed of Y axis going home sensor in backward direction, range: smaller than Y G00 speed.

★38. Z go home positive speed(mm/min)

The speed of Z axis going home sensor in forward direction, range: smaller than Z G00 speed.

★39. Z go home negative speed(mm/min)

The speed of Z axis going home sensor in backward direction, range: smaller than Z G00 speed.

★40. A go home positive speed(mm/min)

The speed of A axis going home sensor in forward direction, range: smaller than A G00 speed.

★41. A go home negative speed(mm/min)

The speed of A axis going home sensor in backward direction, range: smaller than A G00 speed

★42. Spindle max speed in the first gear(rpm)

The max speed of spindle, when run max speed, controller will output 10V analog signal.

★43. Spindle max speed in the second gear(rpm)

★44. Spindle max speed in the third gear(rpm)

★45. Spindle max speed in the fourth gear(rpm)

★46. Second Spindle max speed(rpm)

The max speed of the second spindle, when run max speed, controller will output 10V analog signal.

★47. G02/G03 backlash compensation mode(0 means A: length compensation,8 means B: set by the parameter, +2 means set by G17G18G19 +4 means: Arc IJK endpoint to center)

When D3=0, A type: When interpolation compensation of arc reversal, the speed of compensation is effective with reversal interpolation value, the bigger value, the faster speed to make sure tool will not pause, but the compensation speed can't over 10000mm/min;

+8(D3 bit), B mode: When interpolation compensation of arc reversal, the compensation speed is specified by No.49-No.51 parameter.

+1(D0 bit): Length compensation mode is B mode, otherwise is A mode. A mode is always compensating in Z axis, B mode is specified by G17/G18/G19, G17 compensate Z, G18 compensate Y, G19 compensate X.

+2(D1 bit): The fixed loop mode is B mode, otherwise is A mode. A mode is always compensate in Z axis, B mode is specified by G17/G18/G19, G17 compensate Z, G18 compensate Y, G19 compensate X.

+4(D2 bit): IJK is coordinate from the end point to centre of circle in arc programme, plus 4 means the IJK is to the end point in G02 G03, otherwise is to start point.

- ★ 48, mode B backlash compensation speed (mm/min)
- ★ 48-1, mode B backlash compensation Beginning feed speed (mm/min)[>10]
- ★ 48-2, Acceleration constant of the B type backlash compensation(mm/min)/s[>10]
- ★ 49, Speed Mode [1 means yes, 0 means no]
To set if do speed pre-processing to short line.
- ★ 50, Handwheel stop speed (mm/min) [>100]
Used to set the speed when handwheel stop, bigger value means faster stop.
- ★ 51, Spindle speed when following tapping retracting(rpm)[>1]
Minimum speed of spindle before rotate CCW during tapping;
- ★ 52, Spindle reverse backlash compensation when tapping (pulse)
Spindle backlash compensation before rotating CCW.
- ★ 53, Advanced retract value before spindle reverse(um)[10-5000]
- ★ 54, Tapping retract speed(mm/min)[>=60]
- ★ 58, Hard limit drop speed critical(mm/min)
- ★ 60, Smoothing function(+4:Manual;+8:Handwheel;+16:Program)
- ★ 61, Manual smoothing time constant[2-500]
- ★ 62, Handwheel smoothing time constant[2-500]
- ★ 63, G01/G02/G03 smoothing time constant[2-500]
- ★ 65, Manual enhancement smoothing time constant [2-50]
- ★ 66, Handwheel enhancement smoothing time constant [2-50]
- ★ 67, Program enhancement smoothing time constant [2-50]
- ★ 68, Enhanced smoothing process rating [1-9] (the bigger the rate, the more smooth)
- ★ 101, X-Beginning feed speed(mm/min)[>1]
- ★ 102, Y-Beginning feed speed(mm/min)[>1]
- ★ 103, Z-Beginning feed speed(mm/min)[>1]
- ★ 104, 4-Beginning feed speed(mm/min)[>1]
- ★ 105, 5-Beginning feed speed(mm/min)[>1]
Used to set initialize speed when feed axis doing acceleration, and also the end speed of deceleration speed. If feed axis running speed is lower than P101-P105, there is no acceleration or deceleration. If running speed is higher than P101-P105, acceleration starts from P101-P105 speed.
Attention: the value of P101-P105 is relative to machine configuration, wrong setting may lead to machine malfunction.
Usually, if installed with stepper driver, less than 100, if installed with servo driver, less than 500.
- ★ 111, X-Jump speed at continuous track(mm/min)[>1]
- ★ 112, Y-Jump speed at continuous track(mm/min)[>1]

★ 113,Z-Jump speed at continuous track(mm/min)[>1]

★ 114,4-Jump speed at continuous track(mm/min)[>1]

★ 115,5-Jump speed at continuous track(mm/min)[>1]

Used to set break incremental speed of each axis when axis speed changes during mutli axis interpolation in order to ensure resultant endpoint speed. It means if speed change incremental value is bigger than P111-P115, there is acceleration or deceleration. The purpose is to enhance connection of multi axis interpolation.

For example, if P111=300, during multi axis interpolation, if X speed changes from F800 to F1600, its process should be X axis changes to F1100 firstly, then accelerate to F1600.

★ 200,G00 continue run is valid[1 is No,16 is Yes]

★ 210,Spindle speed fluctuation permillage tolerance during thread[0 means unnecessary, >=2 valid]

★ 211,initial SP speed when start tapping(rpm)

★ 212,initial SP speed when retract tapping(rpm)

★ 213,Static tapping feed spindle acceleration and deceleration (rpm/S)[>1]

★ 214,Acceleration and deceleration of rigid tapping and cutting tool Spindle(rpm/S)[>1]

★ 215,Rigid tapping feed spindle reserved amount (1/1000 laps)[>2]

★ 216,Rigid tapping tool Spindle tail amount(1/1000 laps)[>2]

★ 217,The retention of rigid tapping and returning tool Spindle(1/1000 laps)[>2]

★ 218,Rigid tapping and retracting spindle trailing quantity(1/1000 laps)[>2]

★ 219,Time constant for smooth processing of rigid tapping [20002-20500]

★ 230,SP G00 speed(0.1rpm)

★ 231,SP G01 mode[+4: F key,+8: G90/G91,+16: show value]

+4 means execute SP command at the speed of F value(degree/min) to do orientation(at spindle orientation speed under G00), otherwise execute at the spindle orientation speed.

+8 means SP command is under control of G90/G91, under G90 means absolute reduction, G90 means incremental and not reduction, otherwise SP do reduction and run to nearest direction.

+16 means SP value display will defined bu sending pulse, otherwise defined by encoder feedback.

+8192 means spindle analog will be sent repeatedly per second.

+16384 means after executing M05, both spindle and analog output stop.

★ 232,SP orientate direction under interpolation way[0: Positive,1: Negative]

★ 233,SP home mode(1:pulse,2: by driver, Output M61,check M22; 16 or 32 mean spindle orientate to P234 angle, 16: output M75, check M22)

When set P233=16 or 23, firstly, spindle will stop, then controller send M75 to detect signal M22 from spindle driver(if P233=32, do not detect M22), then controller will calculate spindle current position, then position the degree P235 by the speed of P234. if offset is big, then set Axis parameter P56=16 to reverse feedback direction.

★234,SP oriented stop angle(0.1degree)

★235,SP home speed(0.1 rpm)

3.7.3 Axis parameter

★1,Feed axis band switch[1 mean Yes,0 mean No]

Used to choose the feed speed ratio switch, 1 means choose external ban switch, 0 means use “Feed ↑” and “Feed ↓” button.

Note: when P1=1, external band switch need to connect CN11 port- VDK0 (OFF), VDK1(*100), VDK2(*10), VDK3(*1) signal.

★2,Spindle and G00 band switch[1 mean Spindle,2, mean G00,0 mean No]

Used to choose the spindle speed ratio switch, 1 means choose external ban switch, 0 means use “SP ↑” and “SP↓” button.

Note: when P1=1, external band switch need to connect CN11 port- VDS0 (HCOM), VDS1(Z), VDS2(Y), VDS3(X) signal.

★3,X-axis`s negative scope(mm)

★4,X-axis`s positive scope(mm)

★5,Y-axis`s negative scope(mm)

★6,Y-axis`s positive scope(mm)

★7,Z-axis`s negative scope(mm)

★8,Z-axis`s positive scope(mm)

★9,A-axis`s negative scope(mm)

★10,A-axis`s positive scope(mm)

The movement scope of XYZA in machine coordinate.

★11,Spindle stop time(10ms)

The time which spindle need to brake, namely output time of M05, the shorter brake time means spindle stopes faster.Unit:10ms.

★12,Spindle stop long signal[0 mean No,1 mean Yes]

When P12=1, spindle brake signal is long signal, when P14=0, spindle brake time is short signal.

★13,Soft limited invalid[D2X;D3Y;D4Z;D5A;0 inavaild,0 availd]

D2 means X axis;D3 means Y axis;D4 means Z axis;D5 means A axis;D6 means B axis;D9 means C axis;D10 means Xs axis;D11 means Ys axis;1 means not limit;

Set each axis in each bit. 1 means invalid soft limit in corresponding bit, 0 means valid.

Format: D15D14.....D1D0.

Example: If set soft limit of X axis, then set as:00000100

- ★ 14,X-axis`s reverse backlash compensation(um)
- ★ 15,Y-axis`s reverse backlash compensation(um)
- ★ 16,Z-axis`s reverse backlash compensation(um)
- ★ 17,A-axis`s reverse backlash compensation(um)

If there is backlash in transmission structure when the axis move backward, it is necessary to set backlash compensation. P16-P20c backlash compensation of XYZA. Unit:um.

- ★ 18,X-axis's direction signal[1 mean normal,0 mean reverse]
- ★ 19,Y-axis's direction signal[1 mean normal,0 mean reverse]
- ★ 20,Z-axis's direction signal[1 mean normal,0 mean reverse]
- ★ 21,A-axis's direction signal[1 mean normal,0 mean reverse]

P18-P21 are used to set moving direction of axis, 0 means moving direction reverse from command movement, 1 means axis moving direction is the same as command.

- ★ 22,Close feed electronic gear[1 mean Yes,0 mean No]

Used to disable electronic gear ratio, if P26=1, it means close electronic gear, then P23-P30 will not work.

- ★ 23,X-axis's electronic gear numerator(1-999999)
- ★ 24,X-axis's electronic gear denominator(1-999999)
- ★ 25,Y-axis's electronic gear numerator(1-999999)
- ★ 26,Y-axis's electronic gear denominator(1-999999)
- ★ 27,Z-axis's electronic gear numerator(1-999999)
- ★ 28,Z-axis's electronic gear denominator(1-999999)
- ★ 29,A-axis's electronic gear numerator(1-999999)
- ★ 30,A-axis's electronic gear denominator(1-999999)

Used to set XYZABCXsYs axis electronic gear ratio.

The numerator=10*reduction ratio;

The denominator = ball screw pitch;

If above parameter setting incorrect, axis will move incorrect, the command distance may not match with real movement.

- ★ 31,XYZA positive limit[0 open,1 close]
- ★ 32,XYZA negative limit[0 open,1 close]

Used to set XYZA axis limit type, 0 means Normal open, 1 means Normal close.

★ 33,float zero bit parameter[D3X;D4Y;D5Z;D6A;0 machine Zero;1 float Zero]

Used to set the type of each axis home type, and it is a bit parameter.

D10|D9|D8|D7|D6|D5|D4|D3|D2|D1|D0

D3-D10 corresponds to XYZA home type, 1 mean float zero point, 0 means mechanical home switch;

D1|D0 set if Y axis coordinate reduction;

For example, if just set X axis as float home type, then P33=00000001000.

★ 33-1,X of Reference point 1(mm)

★ 33-2,Y of Reference point 1(mm)

★ 33-3,Z of Reference point 1(mm)

★ 33-4,A of Reference point 1(mm)

★ 34,X coordinate of floating zero point setting

★ 35,Y coordinate of floating zero point setting

★ 36,Z coordinate of floating zero point setting

★ 37,A coordinate of floating zero point setting

P34-P37 will set the current coordinate of XYZA axis as home position, each axis goes home means back here.

If without mechanical zero point, set it as floating zero point. System will locate the zero point rapidly in operation of back to zero point.

★ 38,Feed axis home[1 mean No use, 0 mean clew, 8 compulsion , 9 must compulsion]

Set as 0 means no need, system will not prompt and limit when power on.

Set as 1 means prompt, system will prompt but no limit when power on.

Set as 8 means force, system will prompt when power on, and if no operation of back reference point, it will refuse to execute program.

Set as 9 means super force, motion system of feeding axis will prompt when power on, and if no operation of back reference point, it will refuse to execute motion.

★ 39,Feed axis home mode[0 reverse check,1 reverse No check ,2 No reverse check,3 No reverse No check]

Few methods for setting detection switch and zero pulse signal of motor encoder when each axis is backing to zero point:

Set as 0: When backing to zero point, crush to the reference switch, running reversal after the switch is off, then detect the zero pulse signal of motor encoder.

Set as 1: When backing to zero point, crush to the reference switch, running reversal after the switch is off.

Set as 2: When backing to zero point, crush to the reference switch, continue to

run after the switch is off, then detect the zero pulse signal of motor encoder.

Set as others:When backing to zero point, crush to the reference switch, continue to run after the switch is off.

According to the circuit to set, normally suggest to set as 0 or 2, if not to detect the zero pulse signal of motor encoder, the accuracy will be worse, it only base on switch of reference point.

★40,Home reverse direction parameter[D2X;D3Y;D4Z;D5A; 0 Positive;1 Negative]

Exclusive setting of direction and sequence for every axis.

D10|D9|D8|D7|D6|D5|D4|D3|D2|D1|D0

D2 control X home direction; D3 control Y home direction; D4 control Z home direction; D5 control A home direction; D6 control B home direction, 1 means negative, 0 means positive.

For example, if set X axis home direction is negative, then P40=000000100.

D1 is a status control bit of chuck, 1 means detecting, 0 means without detecting.

If D1=1, after chuck clamping ready M10, system will detect M12, only if M12 is valid, will system execute next step. After chuck unclamping ready M11, system will detect M14, only if M14 is valid, will system execute next step.

★41,Home switch normally closed bit parameter

[D0X;D1Y;D2Z;D3A;1Close;0Open; D6=1 handwheel/auto; D7=1 manual/auto]

Used to set home switch type[NC/NO].

D15|D14|D13|D12|D11|D10|D9|D8|D7|D6|D5|D4|D3|D2|D1|D0

1 means normal close, 0 means normal open. D0 control X home direction; D1 control Y home direction; D2 control Z home direction; D3 control A home direction; D4 control B home switch type; D5 control C home switch type; D14 control Xs home switch type; D15 control Ys home switch type.

For example, if XYZ home switch is NC, then P41=000000000000111.

If D6=1, controller will switch between handwheel and auto mode automatically. If D7=1, controller switch between manual mode and auto mode automatically, controller will switch into manual mode after program finish, pressing Start button in manual mode will switch into auto mode automatically.

★42,X check zero max length(100um)

★43,Y check zero max length(100um)

★44,Z check zero max length(100um)

★45,A check zero max length(100um)

When P39=0 or 2, after release from home switch, each axis need to detect motor encoder zero pulse signal, P42-P45 are the detecting range.

Note: the range must be less than distance by one type of motor, otherwise,

home position accuracy can not be ensured.

★46,X Home offset(10um)

★47,Y Home offset(10um)

★48,Z Home offset(10um)

★49,A Home offset(10um)

During axis homing, when detect modoe zero pulse signal, and move offset vale, then homing finished. Unit: 0.01mm, range: -99999~+99999.

The parameter value depends on installation of home switch and machine coordinate setting.

Note: offset speed is G00 speed.

★50,Run spindle when shifting[1 mean Yes,0 mean No]

Used to set if activate spindle motor when spindle switches gears. 1 means activate, 0 mean not activate, 64 means hold current status.

★51,Shifting Spindle speed(1/100rpm)

The spindle initializing speed setting when spindle switches gear.

★52,Shifting Spindle direction[0 mean M03,1 mean M04]

The spindle rotary direction when spindle switches gear, 0 means rotate CW, 1 means rotates CCW.

★53,Spindle pause time when shifting(10ms)

Used to set the stop time(M05) before initialize spindle when spindle switches gear.

★54,Spindle low-speed time when shifting(10ms)

Used to set spindle initialization time of spindle when spindle switches gear.

★55,Spindle stop time(10ms)

The delay time between canceling M03/M004 and output M05.

★56,Check SP encode[1 mean Yes,0 mean No]

Used to set if check spindle encoder signal. 1 means detect, 0 means not detect.

The parameter is used to activate such function relative to spindle speed like display speed speed, feed vale. And condition is machine need to be installed with encoder which is connected with spindle by 1:1 transmission ratio.

★57,SP encode pulse[4 times encode thread]

The pulse unit per turn of Spindle encoder, the parameter valuse=encoder resolution*4.

★57-1,SP encode alarm pulse value (diagnostics)[>10:Valid]

The tolerant pulse unit of spindle encoder feedback. Effective when more than 10.

★57-2,SP encode pulse[4 times encode thread](set as 0 if Encode:SP is 1:1,

otherwise it must be integer >99)

Four times SP encoder pulse, if the encoder is connected with spindle by 1:1, set parameter as 0, otherwise, the value should be integrator bigger than 99.

★ 58, Whether spindle reversing point[8:Valid]

★ 68, Negative delay time of feeding axis(ms)

The delay time of feed axis when it moves reverse.

★ 80, XZ axis coordinate plan [D2Zworkpiece,D3Xworkpiece,D4Ztool,D5Xtool, D6Zcircumrotate,D7Xcircumrotate]

Used to set if X and Z is rotary axis and do coordinate plan. 1 means yes, 0 means no. The parameter is bit parameter.

D7|D6|D5|D4|D3|D2|D1|D0.

D2 control Z axis work piece coordinate plan; D3 control X axis work piece coordinate plan; D4 control Z axis machine coordinate plan; D5 control X axis machine coordinate plan; D6 control Z axis is rotary axis, D7 control X axis is rotary axis.

★ 81, Y axis function[0 mean circumrotate axis,1 mean line axis]

★ 82, workpiece coordinate when Y is circumrotate axis[0 No;1 plan]

★ 83, machine coordinate when Y is circumrotate axis[0 No;1 plan]

★ 101, A-axis function[0 mean rotating axis,1 mean line axis]

★ 102, machine coordinate when A-axis is circumrotate axis[0 No;1 plan]

★ 220, First spindle full pulse control channel(positive:88, reverse:98)

Set if bus type controller spindle is controlled by pulse, set as 96 means rotate CW, set as 86 means rotate CCW, and following 6th axis.

★ 221, The first spindle full pulse control of the number of pulses per cycle

★ 222, First spindle full pulse speed control(rpm/2ms)

★ 223, Second spindle full pulse control channel (positive: 82Y/84A/85B/86C, reverse:92Y/94A/95B/96C)

★ 224, Second spindle full pulse control of the number of pulses per cycle

★ 225, Second spindle full pulse speed control(rpm/2ms)

★ 250, Ethernet bus servo motor encoder bus number

★ 323, Does the axis of rotation not move at the nearest distance (+4:X;+8:Y/C;+16:Z ;+32:A;+64:B)

★ 404, direction of spindle by pulse(0 reverse,1 normal)

★ 405, SP-axis's electronic gear(0 Yes,1 No)

★ 406, SP-axis's low electronic gear numerator(1-999999)

★ 407, SP-axis's low electronic gear denominator(1-999999)

- ★408,SP-axis's high electronic gear numerator(1-999999)
- ★409,SP-axis's high electronic gear denominator(1-999999)
- ★410,Interpolation tap SP axis[91 X,92 Y/C,93 Z,94 A,95 B]
- ★410a,Y axis tap interpolation[91 X,92 Y/C,93 Z,94 A,95 B]
- ★410a,X axis tap interpolation[91 X,92 Y/C,93 Z,94 A,95 B]
- ★411,Tap mode[2 follow encode;3 interpolation to SP]
- ★412,SP tooth number(<P413)
- ★413,Encode tooth number(>P412)
- ★414,ABC-axis is moving by (7/8/9,17/18/19,27/28/29/D5..D13=1/A by X/Y/Z,C By X/Y/Z,B By X/Y/Z)

3.7.4 Tool parameter

- ★1,C Tool radius compensation's establish(0 mean A,1 mean B)
The method to establish radius C compensation, 0 means A, 1 means B.
- ★2,C Tool radius compensation's cancel(0 mean A,1 mean B)
The method to cancel radius C compensation, 0 means A, 1 means B.
- ★8,Tool mode (0:M06,1:T change,+32768:Tool life management)
In tool compensation interface, press “Redeem” again to enter into tool life management, press “Redeem” once again to back tool compensation.
In tool life management interface, user can set tool times life and tool service life., as well current tool life times and current tool life time, unit is second. Once tool life ends, controller will modify tool compensation value automatically, modification incremental value is defined by parameter, after modification, controller will reset current tool times life or current service life.
- ★32,Tool position signal/WAT signal filter [+256+512+1024: 2/4/8ms of Tool position signal,+2048+4096+8192: 2/4/8ms of WAT signal]
D+number means the bit from right to left:
D8=1 means filter detection signal of tool position by 2ms;
D9=1 means filter detection signal of tool position by 4ms;
D10=1 means filter detection signal of tool position by 8ms, D8-D10 can be 1 at the same time;
D11=1 means filter WAT waiting input signal by 2ms;
D12=1 means filter WAT waiting input signal by 4ms;
D13=1 means filter WAT waiting input signal by 8ms, D11-D13 can be 1 at the same time;

3.7.5 Other parameter

★1,Set sub-panel type

Used to set if installed with hand wheel, 1 means handhold, 0 means panel.

★3,use control switch

If controller is 1000 series, used to set if control switch works, 88 means activated both in manual and auto mode, 99 means activated in auto mode, other values means close.

★4,Have auto lubricate(0 yes/1 no)

Used to set if machine installed with automatic lubricate system.

★5,Auto lubricate time(0.01s)

Used to set auto lubricate time, namely M32 hold time, unit:10ms.

★6,Auto lubricate stop time(0.01s)

Used to set interval time between each lubrication, namely interval time between M32 valid. Unit: s.

★7,Door switch checking(0 no,1 yes)

Used to set if detect door switch signal, if set as 0, means without door switch; if set as 1, means with door switch. It is suggest to detect door switch for safety sake.

Note: 1. door switch is detected through M12;

2. when M12 is valid, in manual mode, feed axis coordinate can move, but in auto mode, system will pause program automatically.

★8,Door switch(0 open,1 close)

Type of door switch signal, 0 means normally open, 1 means normally closed.

★9,bit parameter

D1=1 clear to 0; D2=1 space ;D5=0 close spindle; D6 speed; D8=1 save M10 when power on;D10=1 arrange; D12=1 skip is invalid; D13=1 back to zero is invalid
The format: D15|D14|D13|D12|D11|D10|D9|D8|D7|D6|D5|D4|D3|D2|D1|D0.

D0 bit: Default as 1, can't change.

D1 bit: Set as 1 means the number of workpiece clear automatically when power on, set as 0 means keep.

D2 bit: Set as 1 means insert space into letters automatically when editing the program, set as 0 means not insert.

D3 bit: Default as 0, can't change.

D4 bit: Default as 0, can't change.

D5 bit: Set as 1 means not stop spindle rotation and cooling when pressing RESET, 0 means stop, default is 0.

D6 bit: Set as 1 means each axis work according to own speed, work with nonlinear trajectory when executing G00, 0 means simultaneous, reach at the same time. Default is 1.

D7 bit: Default as 0, can't change.

D8 bit: Set as 1 means save the status M10/M11 of spindle loose or tight when power off, recover this status when power on again. Set as 0 means spindle will be tight automatically when power on.Default is 1.

D9 bit: Default as 1, can't change.

D10 bit: Set as 1 means the number of line is arranged automatically when

programming.

D11 bit: Set as 1, the output analog of the first spindle is the same time from the first, second spindle channel, the function of the second spindle is valid.

D12 bit: Set as 1, shield the skip function, “/” in front of the segment means invalid.

D13 bit: Default as 0, can't change.

D14 bit: Default as 0, can't change.

D15 bit: Set as 1, the tool set show the relative value, otherwise it shows the absolute value.

Pay attention: This parameter includes the bit which can't be changed. If change this bit, it will cause some problems with controller.

★10,Auto count part[1 mean Yes,0 mean No]

Used to count processed work piece quantity.

★11,Program edit number increase

if user want to count program lines automatically, just need to set P11=1.

★13,Interlock between Spindle & chuck(0 mean no)

Used to set if interlock between spindle and chuck.

0 means no relationship between spindle and chuck status;

1 means only if spindle is in M05 status, can chuck clamp or unclamp;

8 means only if spindle is in M05 status and spindle encoder keep still, can chuck clamp or unclamp;

16 means detect speed and interlock;

32 means when program running in auto mode and status is not pause, button of clamp can not work;

56 means super interlock. when program running in auto mode and status is not pause, button of clamp can not work;

The parameter setting depends on machine configuration and user preference, it is suggested to set as interlock in safety sake.

★14,Is available keys of lub&cool as running[1:Yes,0:No]

Used to set if coolant button works in auto mode. The parameter setting depends on user preference, when set it as 1, operator can control coolant system at any time, to meet processing needs.

★17,Servo alarm ALM/X20(0:open,1:close)

Used to set type of XYZA alarm, 0 means normally open, 1 means normal close.

★17-1,Servo ALM/X22(0:open,1:close)

★18,Alarm ALM1/X23(0:open,1:close)

Used to set type of alarm ALM2, 0 means normally open, 1 means normal close.

★19,Alarm ALM2/X24 (0 open,1 close)

Used to set type of ALM3 alarm, 0 means normally open, 1 means normal close.

★20,Chuck control signal(0 single,1 doubleM10/M71)

Used to set chuck control signal quantity, if one-way valve, it needs 1 signal, if with two-way valve, it needs 2 signal.

0: means only one output signal M10 controls chuck clamp or unclamp, when M10 is effective, system executes clamping, when M10 is ineffective, system

executes unclamping;

1: means M71 and M10 signal control chuck unclamping and clamping separately. When M10 is effective and M71 is ineffective, chuck clamps; when M10 is ineffective, and M71 is effective, chuck unclamps. Namely M10 output M10, M11 output M71.

Axis parameter P40-D1 bit is used to set if check clamp/unclamp ready, 0 means without detection; 1 means detection, then system will detect if M14 is effective after outputting M10, detect if M12 is effective after outputting M11, only if M14/M12 is effective, will system continue next step.

★22, Outside chuck control(0 no, 1 yes M16)

Used to set if there is an external switch controlling chuck clamping or unclamping, it is a loop signal, namely chuck status changes everytime when Signal becomes effective once (effective once, then unclamp; effective another 1 time, then clamp). when set as 0, means without external chuck control switch; set as 1, means with external chuck control, the signal is M16.

★24, M10/M11 short signal time(s)

Used to set the hold time of M10, M71 when they are the short signal. If the value is 0, it means M10 and M71 is long signal. Unit: S(second)

★25, Whether to configure an integrated drive [1: Yes, 0: No]

Used to set if connect with NEWKER integrated type driver. If yes, then when driver works normal, controller will output Y05 to control motor brake.

★26, Emerge Stop(0 open, 1 close)

Used to set type of emergency stop button, 0 means normally open, 1 means normally closed. The default setting is normally closed.

★27, Emerge Stop2(0 open, 1 close)

Used to set the type of external emergency stop signal. 0 means normally open, 1 means normally closed.

★28, Run status output(0 invalid, 1 valid Y04 run, Y02 stop)

Used to set if controller output signal for status displaying. 0 means do not output, 1 means output, namely when machine works, if program running, then output Y04, if program stopped, then output Y02.

★29, Alarm status output(0 invalid, 1 valid Y03)

Used to set if output alarm signal, namely when machine is in alarm status, if P29=0, controller will not output alarm signal, if P29=1, controller will output alarm signal Y03.

★30, Set language(1 表中文, 0 mean English)

★31, Is enable PLC program

★32, Is enable High PLC program

Used to set system inner PMC operating. During running machine, it must be enabled.

★35, soft-limit without home as manual [1 Yes, 0 No]

Used to set if soft limit works before the axis go home.

★36, Set system time [year-month-day-hour-minute]

Used to set system time, format: year-month-day-hour-minute.

★37, Velocity of RS232 [0=7200; 1=9600; 2=14400; 3=19200; 4=38400; 5=57600;

6=115200]

Used to set baud rate in RS232 communication.

★37-1,Serial port ModBus station number of OPC function [odd check 10000+,even check 20000+,no check 30000+]

The station number set in RS232, if controller station number is 2, and check mode is odd check, then set as 10002.

★38,Lock Manual rampit func key[8 Yes]

★39,Special parameter

★40,Special parameter

★41,Bake current parameter

Backup current parameter setting as default parameter. After setting machine ready, press P41 twice then set current parameter as default setting for future maintenance.

★42,Resume original parameter

Restore the default parameter setting which is defined by pressing P41 last time.

★50,Run from middle Program ask going last line point[8:Yes,0:No]

Used to choose if position at end of last section before running program in middle line

★120,Manual axis moving keying reverse(4:is X;8:is Y;16:is Z;32:is A)

★200.X axis alarm error between feedback and running. (pulse)[>1]

★201.Y axis alarm error between feedback and running. (pulse)[>1]

★202.Z axis alarm error between feedback and running. (pulse)[>1]

★203.Fourth axis alarm error between feedback and running.(pulse)[>1]

When controller activated position feedback function, if tacking error during axis running is bigger than P200-P204a, system will alarm.

Bigger than 1 is valid. Press “G” to clear the feedback position ,clear position and the alarm.

★205.X axis alarm error between feedback and stop. (pulse)[>1]

★206.Y axis alarm error between feedback and stop. (pulse)[>1]

★207.Z axis alarm error between feedback and stop. (pulse)[>1]

★208.Fourth axis alarm error between feedback and stop. (pulse)[>1]

When controller activated position feedback function, if tacking error after axis stopping is bigger than P200-P204a, system will alarm.

Bigger than 1 is valid. Press “G” to clear the feedback position ,clear position, and the alarm.

★210.X axis feed back electronic gear numerator.

[Automatical count: crew pitch (um) and the number of encoder.]

★211.Y axis feed back electronic gear numerator.

[Automatical count: crew pitch (um) and the number of encoder.]

★212.Z axis feed back electronic gear numerator.

[Automatical count: crew pitch (um) and the number of encoder.]

- ★213.Fourth axis feed back electronic gear numerator.
[Automatical count: crew pitch (um) and the number of encoder.]
If controller connect with feedback encoder AB signal from driver, set P210-P213=10000.
- ★215.X axis feed back electronic gear denominators.
[Automatical count: crew pitch (um) and the number of encoder.]
- ★216.Y axis feed back electronic gear denominators.
[Automatical count: crew pitch (um) and the number of encoder.]
- ★217.Z axis feed back electronic gear denominators.
[Automatical count: crew pitch (um) and the number of encoder.]
- ★218.Fourth axis feed back electronic gear denominators.
[Automatical count: crew pitch (um) and the number of encoder.]
Default as 10000, please do not change it.
- ★ 300.Feed axis matches absolute encoder motor or not. [X—D2, Y—D3,Z—D4,A—D5, “0” means not match, “1” means match.]
If the servo motor is with absolute encoder, it is necessary to set P300 accordingly.
Format: D15|D14|D13|D12|D11|D10|D9|D8|D7|D6|D5|D4|D3|D2|D1|D0
0 means without absolute encoder, 1 means with absolute encoder motor. D2 control X axis; D3 control Y axis; D4 control Z axis; D5 control A axis; D6 control B axis; D7 control C axis; D8 control Xs axis; D9 control Ys axis.
- ★301.Absolute encoder address of lower 16bits multi-turn data.
- ★302.Absolute encoder address of higher 16bits single-turn data
- ★303.Absolute encoder address of lower 16bits single-turn data.
P301=low 16-bit communication address of multiturn absolute in driver;
P302=high 16-bit communication address of single turn absolute in driver;
P303=low 16-bit communication address of single turn absolute in driver;
Attention: Controller communicate with Servo driver through RS485, protocol is as following:
1) Drive station number: 1 means X axis, 2 means Y axis, 3 means Z axis, 4 means A axis, 5 means B axis, 6 means C axis, 7 means Xs axis, 8 means Ys axis.
2) RS485 baud rate is 19200, 8 data bit, 1 stop bit, RTU format, Odd check mode.
- ★304.X-axis one-revolution pulse.
- ★305.Y-axis one-revolution pulse.
- ★306.Z-axis one-revolution pulse.
- ★307.Fourth axis one-revolution pulse.
P304-P307 are used to set resolution of motor absolute encoder, for example, if motor encoder resolution is 17bit, then P304-P307=131072; if motor encoder

resolution is 23bit, then P304-P307=8388608.

★309.X-axis one-revolution coordinate.[nm]

★310.Y-axis one-revolution coordinate.[nm]

★311.Z-axis one-revolution coordinate.[nm]

★312.Fourth axis one-revolution coordinate.[nm]

When the machine installed with absolute encoder motor, P309-P313c are used to set coordinate when motor rotates one revolution, unit is nm. Negative value means reverse direction of coordinate counting.

One-revolution coordinate=(1/Axis parameter electronic gear)x 10⁷

For example, if X axis reduction ratio is 4:1, ballscrew pitch is 5, then X electronic gear ratio will be 8:1, then P309=(1/8)*10000000=2500000.

★314.X-axis multi-turn coordinate offset.[Import “E” to clear multi-turn data]

★315.Y-axis multi-turn coordinate offset. [Import “E” to clear multi-turn data]

★316.Z-axis multi-turn coordinate offset. [Import “E” to clear multi-turn data]

★317.Fourth axis multi-turn coordinate offset. [Import “E” to clear multi-turn data]

When the machine installed with absolute encoder motor, P314-P317 are used to set motor absolute muti-turn offset value, input E will clear absolute multi-turn data, normally it is used to set home position or solve data flow when multi-turn value is too big.

★319,Servo driver current/speed/power(284/283/435)16 bits address.

★320,X-axis one-revolution coordinate denominator

★321,Y-axis one-revolution coordinate denominator

★322,Z-axis one-revolution coordinate denominator

★323,4-axis one-revolution coordinate denominator

When the machine is installed with absolute encoder motor, P320-P323 are used to set one-revolution coordinate denominator, normally, it is 1.

★350,Internet[0:Close,1:Open,8:Open automatically]

★351,IP address of gateway

Set as you want, it is better to keep first three numbers the same to address in LAN, for example: 192.168.1.1.

★352,IP address

It is better to keep first three numbers the same to address in LAN, for example: 192.168.1.103

★353,MAC address

Make sure every piece should be different address, for example:255:255:255:1

★354,IP address of internet service

The IP address of computer, It is better to keep first three numbers the same to address in LAN, for example: 192.168.1.13

Wi-Fi function of USB internet: The network card of USB use EP-N8508GS and

BL-LW05-AR5, others cannot supported currently. The install steps as follows:

1. Install ES browser on Android phone;
2. Open internet of ES browser -->Remote manager-->Set;
3. Set the number of port to be 3721 or 2121 or 2221
4. Set the root directory and select the internal storage of the cellphone
5. Setting up a management account with anonymity
6. Set the code to be GBK mode
7. Open the remote manager (put the IP address shown into the parameter

No.561)

If there isn't Wi-Fi signal, could use Hotspot of cellphone to form LAN:

1. Open internet of ES browser -->Internet manager-->Create internet hotspot
2. Use defined hotspot, set the user name and code
3. Input the name and code to No.362 and No.363 parameter
4. Quit remote manager and enter remote manager (put the IP address shown into

the parameter No.354)

The operation method of entering the FTP server folder on the controller:

- 1、 Press "N" in the program interface(or shift+N).
- 2、 After entering the FTP server folder, press the "N" key (or F6 key) to exit the

FTP server folder according to the same operation above.

The advantage of using FTP to transfer files is that you can see the contents of PC folder on the system, and you can freely choose the files you want to transfer, which is more convenient to use. You can use anonymous login FTP server (no need to set parameter P365, P366), you can also use FTP username and password, FTP username and password using the original wired network FTP username and password.

When the system is connected to the wireless WIFI and the wired Ethernet at the same time, when the FTP server is opened, the wireless WIFI is preferred, and the parameters in the system are as follows:

★361,IP address of FTP Server for wifi Hot[Input based on the value of the FTP server in the phone,As:192.168.2.206]

★362,WiFi hot user name

★363,WiFi hot user code

★364,WiFi hot spot[8:Open,Others:Close]

★365,FTP user name

★366,FTP code

★380,Automatic tool X setting initial coordinate(mm)

★381,Automatic tool Y setting initial coordinate(mm)

- ★382, Automatic tool Z setting initial coordinate(mm)
- ★383, Automatic tool negative high speed(mm/min)
- ★384, Automatic tool positive low speed(mm/min)
- ★385, Automatic tool Z axis coordinate value(mm)
- ★386, Automatic tool Speed of fast locating points(mm/min)
- ★387, Automatic tool setting mode(1:Fixed tool,0:Floating tool)
- ★388, Automatic tool Z axis minimum machine tool coordinate value(mm)
- ★389, Automatic tool Z axis drop value(mm)

Define macro variables of the automatic tool setting gauge function are as follows (corresponding to the other parameters P380 - P389):

#380: The X axis machine coordinate of initial position when automatic tool setting;(Unit:mm)

#381: The Y axis machine coordinate of initial position when automatic tool setting;(unit:mm)

#382: The Z axis machine coordinate of initial position and returning point with automatic tool setting;(unit:mm)

#383: The negative speed of automatic tool setting;(mm/min)

#384: The positive speed of automatic tool setting;(mm/min)

#385: The Z axis coordinate of workpiece surface in current workpiece coordinate system after automatic tool setting;(mm)

#386: The speed which is rapid move to locating position with automatic tool setting;(mm/min)

#387: Automatic tool setting mode (1 means fixed point, 0 means floating point).

#388: The minimal machine coordinate value of Z axis (mm);

#389: The gap value of Z axis [The height which is the gauge surface relative to the workpiece surface(mm)];

Fixed point gauge means putting the gauge in a fixed position, every time the X Y Z axis are automatic running to the fixed point first in tool setting; But the floating point gauge search the tool setting gauge signal along negative of the Z axis.

The input point X25 is default to be the checking point of automatic tool setting gauge to input.

2.The instruction:

M880 (corresponding to ProgramUser0) automatic tool setting instruction;

M882 (corresponding to ProgramUser2),

M883 (corresponding to ProgramUser3) set the gap of Z axis.

3. Automatic tool setting steps:

1)Set the No.380--No.388 parameter in other parameter;

2)Set the No.389 parameter in other parameter to set the drop value of Z axis: this operation needs to be set only once.

A.Run M882 instruction in MDI to set the gap of Z axis;

B.Manual run Z axis to move the tool nose to the workpiece surface;

C.Run M883 instruction in MDI to automatic set the gap of Z axis No.389

parameter in other parameter;

3) MDI choose the workpiece coordinate system G54/G59;

4) Automatic tool setting: MDI running the M880 instruction, automatic set the Z axis offset of the current workpiece coordinate system.

★ 500,Machine tool No.

★ 501,Interface display [1:is white,8:is black]

★ 591.One key to define Step Parameter

★ 592, One key to define Servo Parameter

★ 600,Control type(4000-4099:etherCAT,6000:Modbus,6001:1-6axis

Modbus,6002:3axis Modbus)

★ 601,etherCAT Position loop gain coefficient

★ 602,etherCAT Thread machining position ring gain coefficient

★ 603,etherCAT Position in position allowable difference (number of motor encoder pulses)

★ 610,etherCAT Electronic gear common denominator

★ 611,etherCAT X Electronic gear molecule

★ 612,etherCAT Y Electronic gear molecule

★ 613,etherCAT Z Electronic gear molecule

★ 614,etherCAT A Electronic gear molecule

★ 615,etherCAT B Electronic gear molecule

★ 616,etherCAT C Electronic gear molecule

★ 617,etherCAT Xs Electronic gear molecule

★ 618,etherCAT Ys Electronic gear molecule

★ 620,etherCAT Station number setting [> 10]

★ 621,etherCAT Servo drive type [> 1]

(1 means Maxsine, Aecon/Invt/Estun/STEP/Xinje, 2 means Sanyo Denki/Panasonic A5, 3 means Enpu ,4 means Yakotec/Thinkvo/Panasonic A6/Yuhai, 5 means bichannel Thinkvo, 6 means Tsino-dynatron, 7 means Zhenzheng/+3Eura/+4Dorna/Kinco+6DVS, 8 means Jotong/Weide)

Example: 777777773 means Eura driver; 777777774 means Dorna/Kinco driver; 777777776 means DVS driver.

If the 9th byte is 5, it means delay 1 minutes before communication after power on, for example, P621=666666665 means when connect Tsino-dynatron driver, delay 1 minute before communication in order to make sure driver initializes normally.

★ 622,etherCAT J1 Collision threshold

★ 623,etherCAT J2 Collision threshold

- ★ 624,etherCAT J3 Collision threshold
- ★ 625,etherCAT J4 Collision threshold
- ★ 626,etherCAT J5 Collision threshold
- ★ 627,etherCAT J6 Collision threshold
- ★ 900,User-defined dialog box[1:is invalid,4:is valid,12:is all]
Used to set if activate user-defined dialog when press Enter in main interface.
- ★ 901,Axis home sequence(>9)[5 bits,1/2/3/4 is X/Y/Z/A,last bit must is 0]
Used to set sequence of each axis home. For example, if P901=4521360, it means axis go home sequence is 452136 axis.
- ★ 910,M18/M22/M24/M28 High speed input[1:Yes]
Used to set if define M18/M22/M24/M28 as high speed input of G31/G311.
- ★ 911,Whether enable M18 as the teaching, M28 as the recording function[1:Yes,0:No]
Used to set if activate teaching function by input point M18/M24/M28.
- ★ 912,"Reset" to reset the output interface[1:Yes,0:No]
Used to set if reset output point when press Reset button.
- ★ 994,CNC controller serial number
- ★ 995,Machine tool serial number
- ★ 996,user-defined serial number

Note:

CN13 port of controller is connected to driver by RS485, protocol as follows:

- 1) station address of RS485 is: 1 corresponds to X axis; 2 corresponds to Y axis; 3 corresponds to Z axis; 4 corresponds to the fourth axis.
- 2) Baud rate of RS485 is 19200; data bits is 8 bits; stop bits is 1 bits; format is RTU; odd-even check is odd.

Parameter setting when NEWKer controller matches Delta absolute driver.

1. Parameter of controller
 - P301: set as 102, corresponds to communication address 0x66 of Delta driver parameter P0-51;
 - P302: set as 104, corresponds to communication address 0x66 of Delta driver parameter P0-52;
 - P301: set as -98, corresponds to communication address 0x66 of Delta driver parameter P0-49;
 - P304/P305/P306/P307/P308: XYZABC axis absolute encoder one-revolution pulse, set as 1280000.
2. Parameter of Delta driver
 - P3-00: station number,1/2/3/4 correspond to X/Y/Z/A axis
 - P3-01: set as 2;
 - P3-02: set as 8;
 - P3-03: set as 0;
 - P3-04: set as 0;

- P3-05: set as 1;
- P3-07: set as 0;
- P3-69: set as 1;
- P3-70: set as 2;

Parameter setting when NEWKer controller matches Maxine absolute driver.

1. Parameter of controller:

- (1) P304/P305/P306/P307/P308:XYZABC axis absolute encoder one-revolution pulse, set as 65536.
- (2) if ball screw pitch is not 10mm, electronic gear ratio can be set in driver, they are P029,P030,P031,P032. then one-revolution coordinate of absolute encoder can be set as the real pitch of ball screw, numerator and denominator of feedback will also be real length of ball screw.

2. Parameter of Maxine driver:

(1) parameter relative to bus communication:

- P300: station number;
- P304: 0 means normal mode; 1 means bus mode, set as 1;
- P306: set as 2;
- P307: 0 means incremental position, 1 mean absolute position, set as 1;
- P027,P028 are gear ratio, if multiple of both them is resolution ratio of encoder, controlling accuracy will be better. For 17 bits encoder, P027=8192, P028=16;

After change above parameters, please use E-SET to save data, then restart driver.

- (2) if there is multi-revolution encoder battery, change the 90th parameter as 1, and use Fn36 to initialize the driver.

(3) screw thread processing: default gain parameter is only compatible in thread cutting under spindle speed under 1000r/min. If thread cutting under 2000r/min is required, it is necessary to increase the gain parameter,

- | | |
|------------------------------------|-------------------------------------|
| P005(the first speed loop gain) ; | P009(the first position loop gain); |
| X axis changes from 40 to 80(Hz); | X axis changes from 40 to 80(1/s); |
| Z axis changes from 40 to 100(Hz); | Z axis changes from 40 to 100(1/s) |

3.7.6 Coordinate system

The parameter has the function of multiple coordinate system, includes 6 workpiece coordinate system and a lathe coordinate system G53. A processing program can set a workpiece coordinate system, workpiece coordinate system could move its original to change,the value of coordinate system in parameter is coordinate value of the original point (zero point) in the lathe coordinate system.

Using G54 to G59 to set 6 workpiece coordinate system, in coordinate system interface could modify the coordinate value of original of 6 workpiece coordinate system in lathe coordinate system.

Parameter:

- 1-0,Current group of workpiece coordinate[G54-G59]
- 1-1,X of work coordinates G54-G59(mm)
- 1-2,Y of work coordinates G54-G59(mm)

- 1-3,Z of work coordinates G54-G59(mm)
- 1-4,A of work coordinates G54-G59(mm)
- 1-5,B of work coordinates G54-G59(mm)
- 1-6,C of work coordinates G54-G59(mm)
- 1-7,Xs of work coordinates G54-G59(mm)
- 1-8,Ys of work coordinates G54-G59(mm)
- 2-0,Current group of workpiece coordinate[G54.1-G54.48]
- 2-1,X of work coordinatesG54.1-G54.48(mm)
- 2-2,Y of work coordinatesG54.1-G54.48(mm)
- 2-3,Z of work coordinatesG54.1-G54.48(mm)
- 2-4,A of work coordinatesG54.1-G54.48(mm)
- 2-5,B of work coordinatesG54.1-G54.48(mm)
- 2-6,C of work coordinatesG54.1-G54.48(mm)
- 2-7,Xs of work coordinatesG54.1-G54.48(mm)
- 2-8,Ys of work coordinatesG54.1-G54.48(mm)
- 1,X of work coordinates G54(mm)[Incremental input, E start entry means absolute]
- 2,Y of work coordinates G54(mm)
- 3,Z of work coordinates G54(mm)
- 4,A of work coordinates G54(mm)
- 6,X of work coordinates G55(mm)
- 7,Y of work coordinates G55(mm)
- 8,Z of work coordinates G55(mm)
- 9,A of work coordinates G55(mm)
- 11,X of work coordinates G56(mm)
- 12,Y of work coordinates G56(mm)
- 13,Z of work coordinates G56(mm)
- 14,A of work coordinates G56(mm)
- 16,X of work coordinates G57(mm)
- 17,Y of work coordinates G57(mm)
- 18,Z of work coordinates G57(mm)
- 19,A of work coordinates G57(mm)
- 21,X of work coordinates G58(mm)
- 22,Y of work coordinates G58(mm)
- 23,Z of work coordinates G58(mm)
- 24,A of work coordinates G58(mm)
- 26,X of work coordinates G59(mm)
- 27,Y of work coordinates G59(mm)
- 28,Z of work coordinates G59(mm)
- 29,A of work coordinates G59(mm)
- 30,B of work coordinates G59(mm)
- 41,X of work coordinates G54.1(mm)
- 42,Y of work coordinates G54.1(mm)
- 43,Z of work coordinates G54.1(mm)
- 44,A of work coordinates G54.1(mm)

45,B of work coordinates G54.1(mm)
46,X of work coordinates G54.2(mm)
47,Y of work coordinates G54.2(mm)
48,Z of work coordinates G54.2(mm)
49,A of work coordinates G54.2(mm)
50,B of work coordinates G54.2(mm)
51,X of work coordinates G54.3(mm)
52,Y of work coordinates G54.3(mm)
53,Z of work coordinates G54.3(mm)
54,A of work coordinates G54.3(mm)
55,B of work coordinates G54.3(mm)
56,X of work coordinates G54.4(mm)
57,Y of work coordinates G54.4(mm)
58,Z of work coordinates G54.4(mm)
59,A of work coordinates G54.4(mm)
60,B of work coordinates G54.4(mm)
61,X of work coordinates G54.5(mm)
62,Y of work coordinates G54.5(mm)
63,Z of work coordinates G54.5(mm)
64,A of work coordinates G54.5(mm)
65,B of work coordinates G54.5(mm)
66,X of work coordinates G54.6(mm)
67,Y of work coordinates G54.6(mm)
68,Z of work coordinates G54.6(mm)
69,A of work coordinates G54.6(mm)
70,B of work coordinates G54.6(mm)
71,X of work coordinates G54.7(mm)
72,Y of work coordinates G54.7(mm)
73,Z of work coordinates G54.7(mm)
74,A of work coordinates G54.7(mm)
75,B of work coordinates G54.7(mm)
76,X of work coordinates G54.8(mm)
77,Y of work coordinates G54.8(mm)
78,Z of work coordinates G54.8(mm)
79,A of work coordinates G54.8(mm)
80,B of work coordinates G54.8(mm)
81,X of work coordinates G54.9(mm)
82,Y of work coordinates G54.9(mm)
83,Z of work coordinates G54.9(mm)
84,A of work coordinates G54.9(mm)
85,B of work coordinates G54.9(mm)
86,X of work coordinates G54.10(mm)
87,Y of work coordinates G54.10(mm)
88,Z of work coordinates G54.10(mm)

89,A of work coordinates G54.10(mm)

90,B of work coordinates G54.10(mm)

3.7.7 Password

In this system in order to prevent from the parameter modification in accident, make sure the lathe working, the system adopts the parameter setting of classify the authority. Divided into "CNC factory" and "Lathe factory", "User factory" three level authority. The "CNC factory" set for the function of the system,belong to internal parameter;"Lathe factory" set equipment configuration of lathe and mechanical index and some parameter about safety;"User factory" set processing technology, performance and the processing program.

The initial situation of three-level classification in this system: "CNC factory" is enabled,"Lathe factory"and "User factory" both are not enabled. If you want to enable the authority function, you must use the initial password to enable access function, then set the corresponding new access password to enable.Pay attention to the initial code is only be used once, the code will invalid after setting a new code, please remember the new code.

Pay attention: the code must be 6 digits, the code can be number and letter.

Parameter:

1. Is enable CNC Co.' password
2. Is enable Machine Co.' password
3. Is enable User' password
4. Modify CNC Corporation.'s password
5. Modify Machine Corporation.'s password
6. Modify User's password
7. Curry work time
8. Software version

3.8 Tool compensation

Press "Redeem" to enter interface of redeem in any interface, including "Radius compensation" "Length" "Clear all value" "Clear current value" "Set tool" "Posit tool" "Set", total 7 functions, correspond to press"N"、"T"、"R"、"Q"、"A"、"B"、"C" to enter corresponding interface, press "Esc" to back the primary menu interface.

3.8.1 Radius compensation

Press "N" to enter radius compensation interface in redeem interface. The parameter is used to set adopt corner radius of the tool.

Setting method: Press "↑ ↓" to make cursor move to the corresponding tool and press "Enter" to popup a dialog box, import corresponding tool radius(Absolute value), press "Enter" at last.

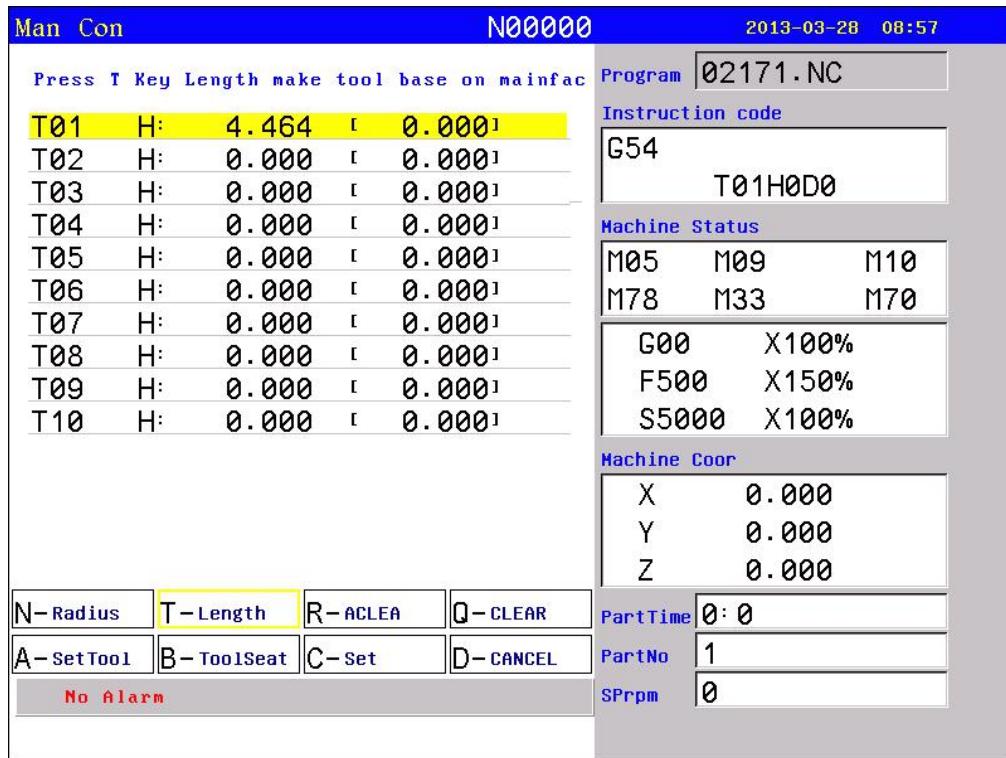

3.8.2 Length compensation

Press “T” to enter length of redeem interface. The parameter is used to modify the length which is adopt or reset the length.

Method of modifying the length:

Press “↑ ↓” to make cursor move to the corresponding tool number and press “Enter” to popup a dialog box, import the modifying axis into the dialog box and import the modifying value(import 0.05 to plus 0.05, import -0.05 to reduce 0.05), press “Enter” to confirm. The system calculates current value of redeem after finishing setting.

Method of set tool automatically:

Make lathe move to a position so that measure corresponding tool coordinate, press “↑ ↓” to make cursor move to corresponding tool number and press “A” to popup a dialog box, import the reset axis into dialog box and import the value of measuring the workpiece of corresponding axis, press “Enter” to confirm. The length compensation of corresponding axis has been reset. The system automatical refresh current value of redeem after finishing setting.It also can be set in manual status, press “H” in manual status to set tool automatically.

Method of initializing the length compensation value and radius of tool:

Press “R(Clear all)” or “Q(Clear the current)” to initialize all the length compensation or current length compensation.

Pay attention: the length compensation can be positive or negative number, but the radius compensation only can be positive number.

3.8.3 Posit tool

Press “B” to enter posit tool interface in redeem interface. The parameter is used to

set the kind of tool when adopting radius compensation of tool.

Method of setting: Press “↑ ↓” to make cursor move to corresponding tool number and press “Enter” to popup a dialog box, import the code of corresponding tool kinds and press “Enter” to confirm.

Press “N” to initialize all the kinds of tool.

3.8.4 Set quantity

Press “C” to popup a dialog box in the redeem interface to set and manage the total tools. The quantity of the tool in this system can be set 99.

3.9 Screw compensation

Press “Parameter” twice in parameter interface to enter screw compensation interface to set the screw compensation.

Screw compensation is used for automatical compensating the error of screw pitch, compensate the influence from the error of screw pitch to the prevision of operating lathe. The system adopts storage mode of screw compensation: Making the lathe’s home point as the starting point when debugging, measured the error curve of screw, studied out the correctional curve according to the error curve, import the value of correctional curve into the correctional parameter and system is going to compensate according to the parameter in automatical running.

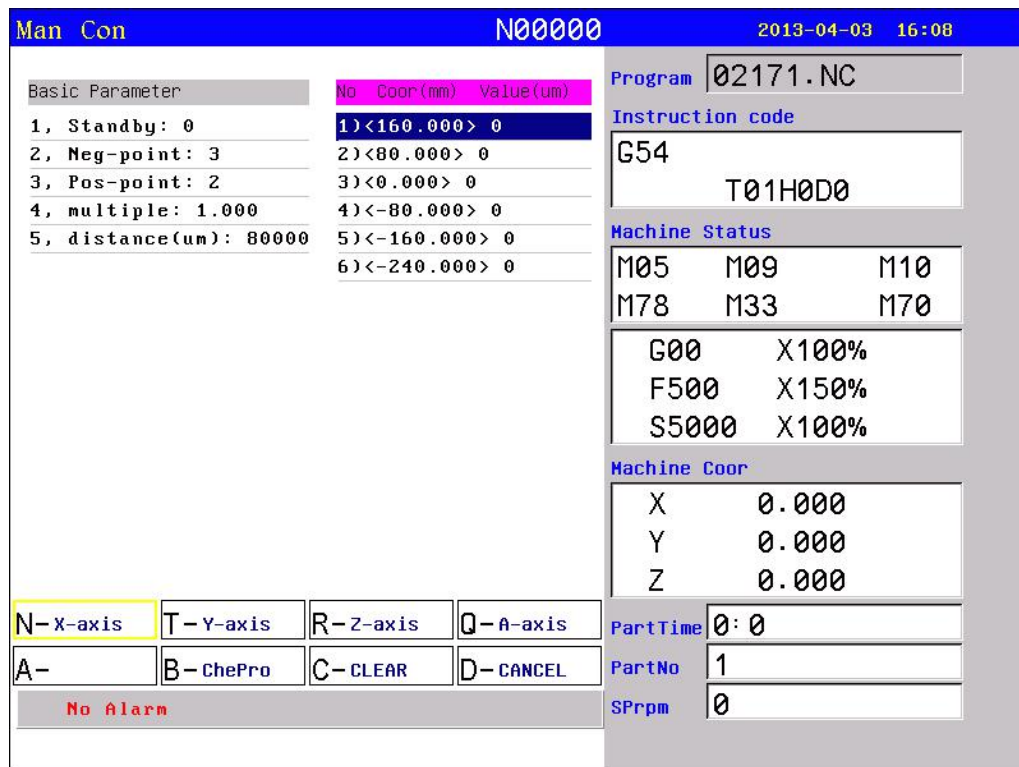

Screw compensation interface

Screw compensation by the axis as the unit to set storage, set X Y Z axis separately, by pressing “N” “T” “R” to switch; Every axis of screw compensation interface has tow areas(basic parameter and set the compensation), by pressing “→ ←”to move the

cursor to realize.

Basic parameter:

Press “↑ ↓” to select current basic parameter to set in basic parameter, press “Enter” to popup a dialog box to import the error compensation of every axis and import the basic information of screw compensation.

Set compensation value:

In the area of setting compensation, it will shows the value of compensation and every axis’ error compensation point of screw pitch. Press “↑ ↓ PgDn PgUp” to select current compensation point and press “Enter” to popup a dialog box to import the value of compensation, import the value of current compensation point.

Man Con		鑫科瑞数控	N00000	2014-07-19	10:30
Basic Parameter 1, Standby: 0 2, Neg-point: 3 3, Pos-point: 2 4, multiple: 1.000 5, distance(um): 80000		No. Coor(mm) Value(um) 1) <160.000> 0 2) <80.000> 0 3) <0.000> 0 4) <-80.000> 0 5) <-160.000> 0 6) <-240.000> 0		Program G110 Instruction code G53 T02H0D0	
5, distance(um): <input type="text" value="80000"/>				Machine Status M05 M09 M10 M78 M33 M70 G00 X100% F250 X150% S0 X100%	
				Machine Coor X 2.921 Y 0.000 Z -14.930	
N-X-axis	T-Y-axis	R-Z-axis	Q-	PartTime 0: 3	
A-	B-ChePro	C-CLEAR	D-CANCEL	PartNo 596	
No Alarm				SPrpm 0	

Man Con 鑫科数控 N00000 2014-07-19 10:30

Basic Parameter		No	Coor(mm)	Value(um)
1, Standby:	0	1)	<160.000>	0
2, Neg-point:	3	2)	<80.000>	0
3, Pos-point:	2	3)	<0.000>	0
4, multiple:	1.000	4)	<-80.000>	0
5, distance(um):	80000	5)	<-160.000>	0
		6)	<-240.000>	0

5, distance(um):
p

N-X-axis	T-Y-axis	R-Z-axis	Q-
A-	B-ChePro	C-CLEAR	D-CANCEL

No Alarm

Program G110

Instruction code
G53
T02H0D0

Machine Status

M05	M09	M10
M78	M33	M70
G00	X100%	
F250	X150%	
S0	X100%	

Machine Coor

X	2.921
Y	0.000
Z	-14.930

PartTime 0: 3

PartNo 596

SPrpm 0

Test program generate automatically

Automatical generate a program of laser interferometer to check the screw compensation. Enter the screw pitch interface and set basic parameter, press checking program to popup a dialog box and press “Enter” to generate corresponding checking program of screw compensation.

The number of compensation points can be set freely, the maximum number of each axis is 300. The basic parameter of every axis’ error compensation of screw pitch includes as follows:

1. Reserve.
2. Backward checking points.
3. Forward checking points.
4. Compensation override.
5. The spacing of compensation points (um).

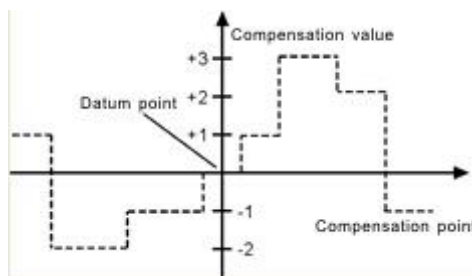

The system calculates every axis' error compensation points' positions of screw pitch according to basic parameter automatically, every axis's error compensation points' spacing is uniform, user can import compensation value of each point (This system requires importing absolute value, relating the of home point).

The compensation points are uniform, set the spacing into each axis.

For example:

Example 1: Linear axis: when length of travel is -400mm ~ +800mm, spacing of points is 50mm, reference point compensation is No.40, it can figure out that Compensation point of farthest end in negative direction is:

Machine negative travel/point interval +1=40-400/50+1=33.

Compensation point of farthest end in positive direction is:

Machine positive travel/point interval +1=40+800/50=56.

The corresponding relationship between machine coordinate and compensation point is:

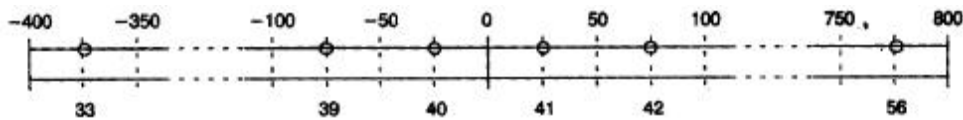

output compensation value in 0 position

parameters set as follows:

Compensation point No. of reference point: 40

Compensation point No. of farthest end in negative direction: 30

Compensation point No. of farthest end in positive direction: 56

Compensation override: 1

Compensation point interval: 50000

Corresponding compensation point and value:

The compensation value in corresponding compensation point:

No.	33	34	35	36	37	38	39	40	41	42	43	44	45	46	47	48	49	56
Value	+2	+1	+1	-2	0	-1	0	-1	+2	+1	0	-1	-1	-2	0	+1	+2	+1

The contrasted chart of compensation points and value as follows:

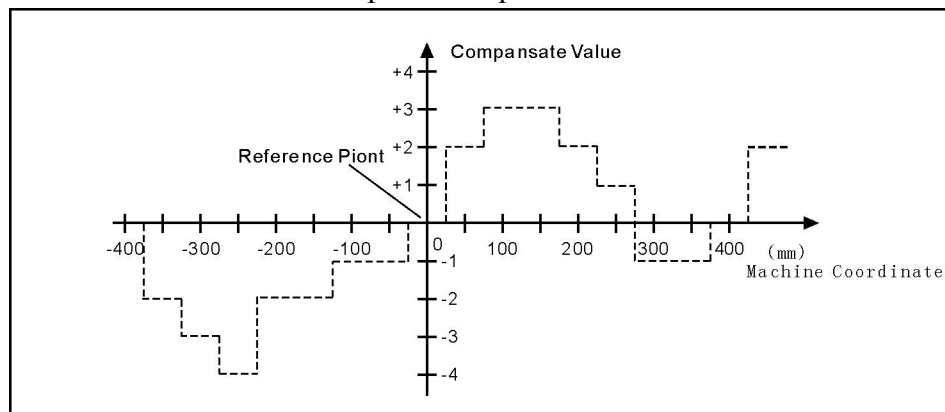

Example 2: rotor axis: when movement per revolution is 360°, interval of points

45°,reference point compensation NO. 60, Compensation point NO. of farthest end in negative direction is usually same as reference point compensation point NO.

Compensation point NO. of farthest end in positive direction is:

Reference compensation point NO.+ movement per revolution/compensation point interval=60+360/45=68.

Machine coordinate and compensation point NO. correspondence is:

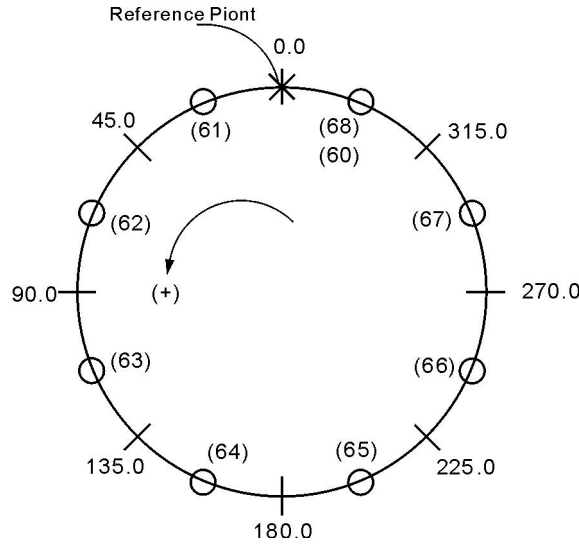

Note: input value in small circle. If the total amount from 61 to 68 doesn't equal 0, accumulated pitch error per revolution will deviate, so same value shall be put in 60 and 68.

Output compensation value at corresponding point:

NO.	60	61	62	63	64	65	66	67	68
VALUE	+1	-2	+1	+3	-1	-1	-3	+2	+1

Compensation point and value contrast:

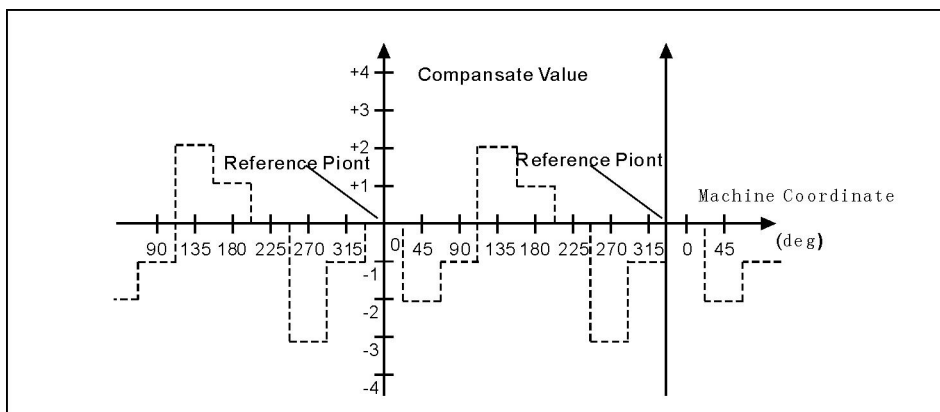

3.10 Diagnosis

Press "Diagnosis" to enter the diagnosis interface in parameter interface.

System diagnosis interface(Input signal)

Press "T" and "Pgup Pgdn" to check the status of input and output, press "Q" to

check alarm information.

Man Con		N00000								2013-03-28 08:57	
Input point										Program 02171.NC	
X00 T01	X01 T02	X02 T03	X03 T04	X04 T05	X05 T06	X06 T07	X07 T08			Instruction code	
0	0	0	0	0	0	0	0			G54	
X08 M34/A0	X09 -L	X10 +L	X11 M36/Y0	X12 X0	X13 Z0	X14 KRUN	X15 KHALT			T01H0D0	
0	0	0	0	0	0	0	0			Machine Status	
X16 X20	X17 Z20	X18 KLEFT	X19 KRIGHT	X20 STOP	X21 TOK	X22 ALM	X23 ALM1			M05 M09 M10	
0	0	0	0	0	0	0	0			M78 M33 M70	
X24 ALM2	X25 M28	X26 M24	X27 M22	X28 M18	X29 M12	X30 M14	X31 M16			G00 X100%	
1	1	1	1	1	1	1	1			F500 X150%	
X32 HX/DS8	X33 HY/DS4	X34 HZ/DS2	X35 HA/DS0	X36 HX1/K8	X37 HX10/K	X38 HX100/	X39 HOFF/K			S5000 X100%	
										Machine Coord	
										X 0.000	
										Y 0.000	
										Z 0.000	
N-				T-I/O		R-		Q-ALARM		PartTime 0:0	
A-				B-Reset		C-		D-CANCEL		PartNo 1	
No Alarm										SPrpm 0	

Man Con		N00000								2013-03-28 08:57	
Output Point										Program 02171.NC	
Y00 M61	Y01 M63	Y02 M65	Y03 M67	Y04 M69	Y05 M71	Y06 M73	Y07 M59			Instruction code	
0	0	0	0	0	0	0	0			G54	
Y08 M32	Y09 M79	Y10 M10	Y11 M08	Y12 M05	Y13 M04	Y14 M03	Y15 M75			T01H0D0	
0	0	0	0	0	0	0	0			Machine Status	
Y16 LRUN	Y17 INTH	Y18 +T	Y19 -T	Y20 S04	Y21 S03	Y22 S02	Y23 S01			M05 M09 M10	
0	0	0	0	0	0	0	0			M78 M33 M70	
										G00 X100%	
										F500 X150%	
										S5000 X100%	
										Machine Coord	
										X 0.000	
										Y 0.000	
										Z 0.000	
N-				T-I/O		R-		Q-ALARM		PartTime 0:0	
A-				B-Reset		C-		D-CANCEL		PartNo 1	
No Alarm										SPrpm 0	

Checking interface of output signal

In the interface of output or input, No.0 or No.1 stands for status, 1 means effective, 0 means no effect.

Man Con		鑫科瑞数控		N00000		2014-07-19 10:33	
Clear history press DEL key, Reset Alarm pre				Program G110			
Spindle encode check: 0 (No 1 encode)				Instruction code			
1, [Curent Alarm]: NO				G53			
2, [History Alarm](13h46m): Emergent Stop				T02H0D0			
				Machine Status			
M05		M09		M10			
M78		M33		M70			
G00		X100%					
F250		X150%					
S0		X100%					
				Machine Coord			
X		2.921					
Y		0.000					
Z		-14.930					
N-		T- I/O		R-		Q- ALARM	
A-		B- Reset		C-		D- CANCEL	
No Alarm				PartTime		0: 3	
				PartNo		596	
				SPrpm		0	

Alarm information interface

The first line in this interface shows the number of spindle encoder, the number of current and historical alarm information is record total 10, the superfluous part is clear automatically, only shows 10 alarm information recently.

PLC interface and edition:

Press “R” to check PLC ladder, press “A” to edit PLC ladder, press “S” to search when editing or diagnose PLC ladder. After editing and saving PLC, new PLC will be executed when the controller restart. If you want PLC to be executed immediately, please press”R” in PLC diagnosis interface.

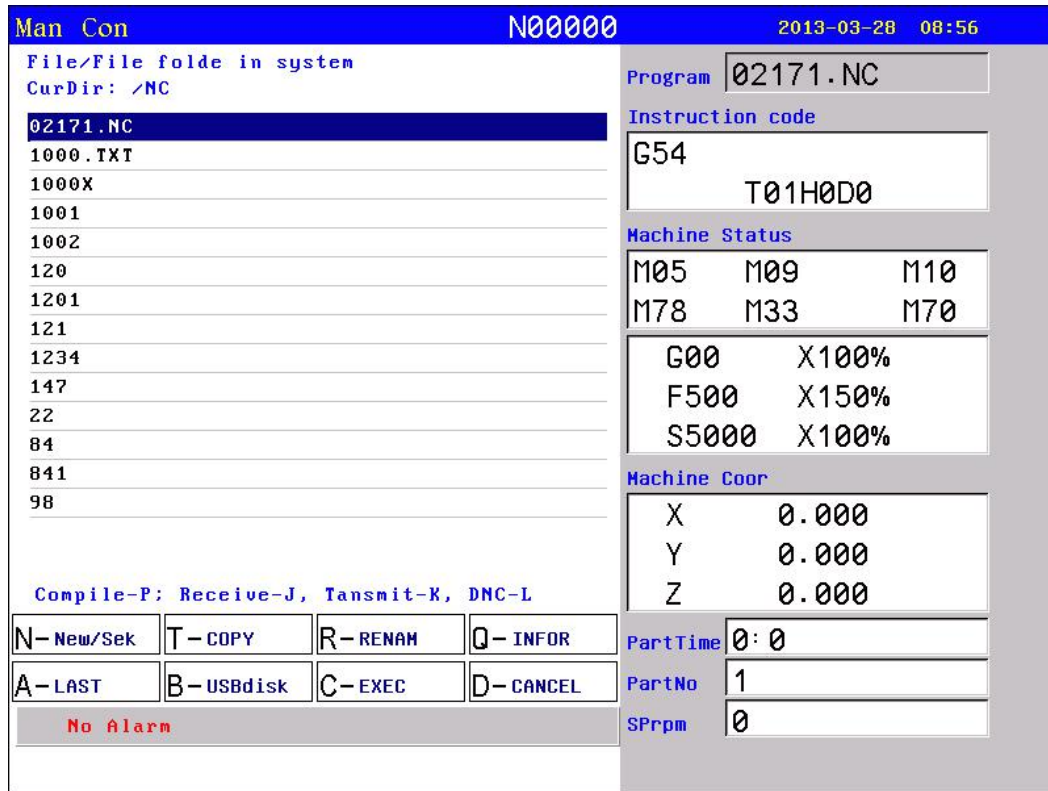

Center part of screen for program display, current program is showed by reverse display, move PgUp、PgDn to choose program, and then press“Enter”to edit current program. Functional keys“N、T、R、Q、A、B、C、D” include: “new file/search”、 “copy”、 “rename”、 “information”、 “last grade”“USB disc”、 “execute program”、 “cancel”.

3.11.1 Editing

Select “New file/search” to popup a dialog box to import the name of program, if the name is existent, the quondam program is called up; If the name is inexistent, the system will build a new file.

The name of program can be number, letter or mix, the length is 100 bits.

The system doesn't allow the namesake, build a new program or select a program and press “Enter” to enter the editing interface.

The file name and the Chinese input of program content:

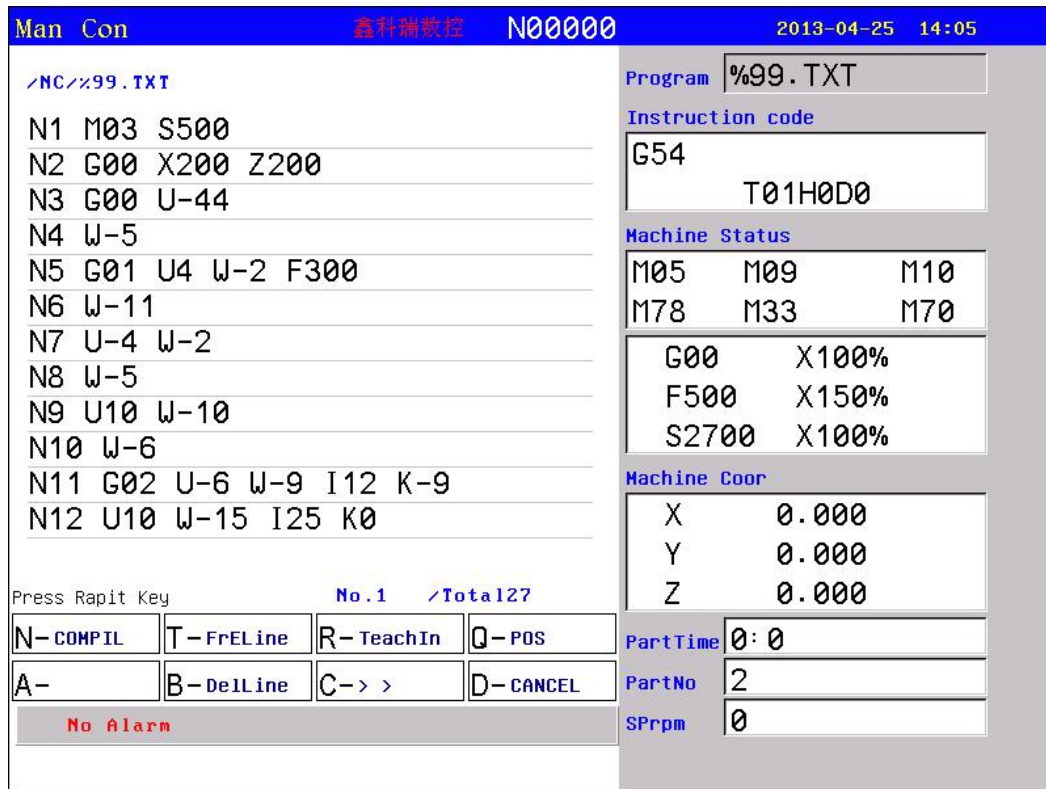

The directory interface of the "new / search", "copy", "rename", "to copy into the system", "to copy into the USB" can enter the Chinese characters; change the input method according to the prompt of system. Also can input Chinese characters in program editing interface according to the prompt of system.







The screen prompts the editing program name at the top left corner in the editing status; The left is the content, the right is the information for lathe status, the operation in the editing status as follows:









- (1) The current cursor locate:
 Press “↑↓←→” to move the cursor to any position of program content
 Press "Pgup" to the last page.
 Press "Pgdn" to the next page.
- (2) Character modification: Delete the character at the position of the cursor, then enter the new character.
- (3) The character insertion: Enter a new direct character at the cursor position. When the input is the letter, the letter in front of automatically generating space. If you want to enter a space, first enter a letter, and then delete this letter.
- (4) The character deletion: Press "Del" directly at the cursor position
- (5) Inset the line: Press "Enter" directly, inset a line in front of the current line if the cursor is at the first line, otherwise insert a line after the current line.
- (6) "Fast" superposition key operation:

The first function:

- A, “”+“N”: compile the program.
- B, “”+“J”: to the fist line or last line of the program.
- C, “”+“V”: teaching function, enter the handwheel status; Press "Q" to read the tool coordinate in the current workpiece coordinate system according to the corresponding axis X/Y/Z/A (all the axis).

- D, “”+“Q”: located to the specified line.
- E, “”+“A”: no operation.
- F, “”+“B”: delete the current line.
- G, “”+“C”: the first or second page selection.
- H, “”+“D”: Chinese characters and character input conversion.

The second function:

- A, “”+“N”: delete the program block.
- B, “”+“J”: copy the specified program block.
- C, “”+“V”: sort the program.
- D, “”+“Q”: to find the specified character.
- E, “”+“A”: replacing the specified character.
- F, “”+“B”: all the content to are replaced by the specified character.
- G, “”+ “C”: the first or second page selection.
- H, “”+“D”: Chinese characters and character input conversion.

3.11.2 Copy

Press “↑ ↓” in program main interface to select program which need to copy and press “T” to prompt a dialog box to import a new name of program, to copy which is the same content but different name so that to modify, rename and back-up copy.

3.11.3 Delete

Press “↑ ↓” in program main interface to select program which need to delete and press “Del” to delete the program.

The operation of delete need to be careful, it can't be recovery.

3.11.4 Rename

Press “↑ ↓” in program main interface to select program which need to rename and press “R” to popup a dialog box to import a new name.

3.11.5 Information

Press “↑ ↓” in program main interface to select program which need to check and press “Q” to popup a dialog box to check the size of program and the remainder space of the system.

3.11.6 Checking program

Press “↑ ↓” in program main interface to select the checking program and press “P”, the system will check the form and grammar of program. Prompting when finding mistake.

3.11.7 Folder management

You can build a file in this system, Press “N” in program main interface to import a file name and press “.” to build a folder and it will prompt a “folder” after the name.

Move the cursor to the file name and press “Enter” to open to build a new file or folder in it.

Press “A” go to the last folder.

Move the cursor to the file name and press “Del” to delete the folder.

3.11.8 Select automatic program to run

Press “↑ ↓” in program main interface to select a program and press “C” to select the program and switch into the last interface.

3.11.9 Program communication

The system could adopt the RS232 serial port to deliver files.

Delivery (Transport)

Deliver the selected program in this system to another system or to PC to save.

Press “↑ ↓” in program main interface to select program and press “J” to deliver, press “Reset” to interrupt in the deliver process.

Reception

Receive the selected program in another system or PC (Must be text file form).

Press “K” to import a name of received program into the dialog box in program main interface, press “Reset” to interrupt in the receive process.

Pay attention: 1. Using the exclusive communication software to deliver program in User’s PC.

2. The speed of deliver of PC must be the same as the speed of receive, defeat otherwise.

3. The length of RS232 can’t greater than 10 meters.

4. The number of serial port must be the same as the system setting.

5. Editing program of PC must be text file form.

3.11.10 U-disk management

To exchange files of parameter or program with other system or PC by U-disk. It also can upgrade or back-up the software or parameter in system.

Pay attention: The name of folder can’t contain of space symbol.

Press “B” to enter the U-disk management interface in program main interface when U-disk connects the USB port. Press “B” again to back to the system interface.

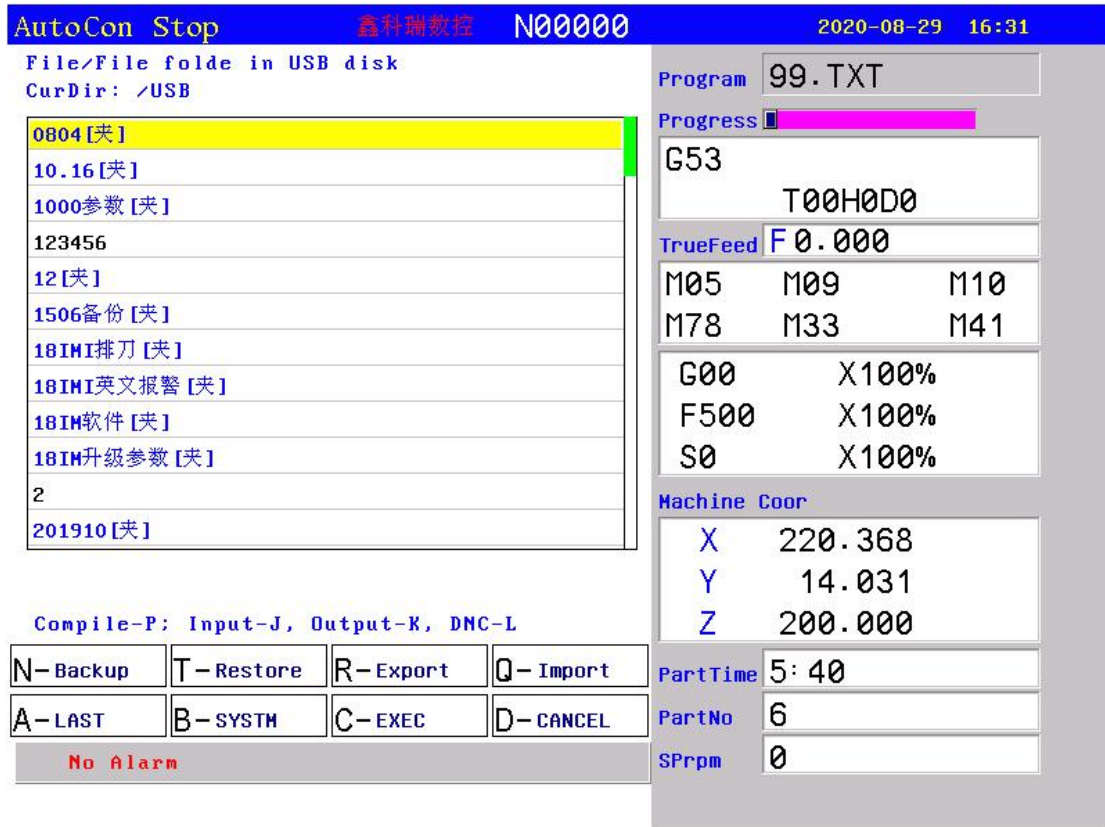

A. The processing program management

Copy the files or folder of U-disk into system

After connecting the U-disk, press “B” to enter the U-disk directory in program main interface. Press “↑ ↓” to move cursor to select file or folder to copy and press “Q” to popup a dialog box to import name, press “Enter” to confirm. If there is the same name of program in the system, it will popup a dialog box to ask if cover the file or folder or not.

Press “J” to copy all the program in USB into system.

Copy the files or folder of system into U-disk

Press “↑ ↓” to move cursor to select file or folder and press “B”, press “R” to popup a dialog box to import name in U-disk interface and press “Enter” to confirm. If there is the same name of program in the system, it will popup a dialog box to ask if cover the file or folder or not.

Press “K” to copy all the program in system into USB.

Pay attention: Before unplugging the U-disk must return to the display system of program files directory interface. (Exit U-disk interface)

Otherwise the date which is copied just now will be loss.

The name of folder can’t have space symbol when using U-disk.

B. Using U-disk to manage parameter and system software

The system could use U-disk to deliver files or system software to upgrade and update, back-up files and parameter, the method of operation is as follows:

Using U-disk to copy parameter and system software into system(Upgrade, update).

First U-disk inserts the USB port and press “Program” to enter program main

interface, press “B” to show the files in U-disk. Press “↑ ↓” to move the cursor to select a folder which is going to be copied into system and press “Enter” to open it, press “T” to import code when appearing the files and press “Enter” to confirm, wait for seconds to copied the parameter successfully. Press “B” to exit U-disk after copying successfully, restart the system, the system will reloads the new files to upgrade the parameter.

Pay attention: The parameter is better to be derived into a separate folder in U-disk to defend from the error operation to destroy the system files.

To derive or back-up parameter files by U-disk

First U-disk inserts the USB port and press “Program” to enter program main interface, press “B” to show the files in U-disk. Press “N” to import the code and press “Enter” to confirm, wait for seconds to derive successfully. The parameter in system is already derived into U-disk. Press “B” to exit U-disk.

Pay attention: The U-disk is empty better to arrange the files (Parameter files is lots of about several dozens) so that derive parameter or create a folder on your computer first, open the folder before deriving to derive the parameters into the folder.

3.11.11 Convert DXF files into G code.

In program directory, choose the DXF file then press“-”, it will be converted into G code file, whose name extension is .CNC. The format of the DXF file input into controller should be .DXF or .dxf. Parameter refers to process parameter No.400-402.

During generation of G code files, system will generate corresponding head and end code according to if there are HEADDXF.TXT and ENDDXF.TXT (or headdxf.txt and enddxf.txt) under current file directory.

Attention: head code file and end code file must be under current file directory.

Chapter 4 Programming

CNC machine is highly effective automatic equipment according to programmed program to process work piece. Programming is using the CNC system control language according to the requirement and drawing of the work piece to describe the processing trajectory and the assistant action. Ideal system not only could promise process qualified work piece, but also make the functions of cnc machine reasonable application and fully use, so it is very important to programming, this chapter will introduce many kinds of instructions and usage of CNC program, please read carefully.

4.1 Basic concepts

Program Segment: It is a complete command line consisted of instruction segment and data segment.

Program: is a congregation of program segment by machining logic structure in order to complete the machining of workpiece.

Machine Coordinate System : The establishment of coordinate is based on machine's zero point. The milling machine coordinate axis and its direction should follow to "ISO841" standard. The method as follow: Through right hand rule we can make the program coordinate, The Z axis is parallel as spindle, The X axis is horizontal, The Y axis is determined by right hand rule. The A, B, C are rotated axis or assistant axis which parallel as X,Y,Z axis. Furthermore, The coordinate axis direction is the increasing workpiece dimension direction.

As no work coordinate, make machine coordinate as work coordinate.

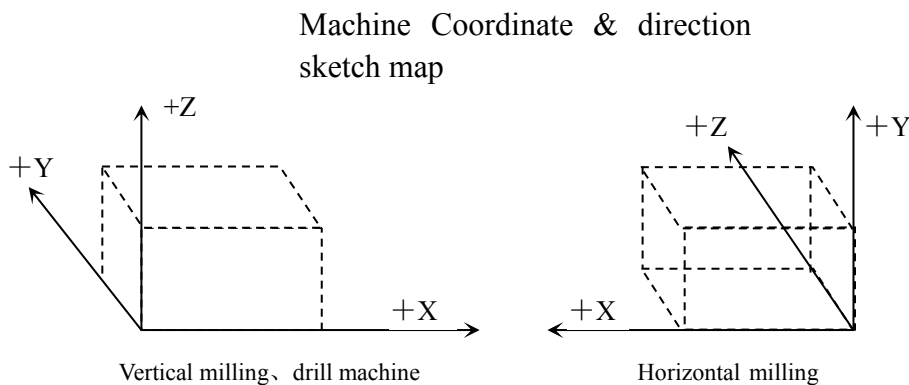

Working Coordinate System: Work piece processing uses the coordinate system is called as the work piece coordinate system, it is set by CNC. The work piece coordinate system could change to move its zero point.

Set the work piece coordinates:

1.Use G54 ~ G59: Use operating parameter set coordinate system may set 6 work piece coordinate system.

2.G52 instruction: Set a value in front of G52 instruction to set the workpiece coordinate system in program.

With absolute value instruction ,it must use the above method to establish the work piece coordinate system

Absolute Programming : It is confirmed coordinates data programming mode based on established absolute coordinate system.。 It is settlements by “G90”。

Relative Programming(increment programming)**:** It is distance and direction of operation end point ,compared with starting point. It is settlements by “G90”。

Mode Instruction: The instruction which can remain the function in the program.It works both in this program and program in the future.

In the same operation, there may be several mode instruction, such as M03(spindle clockwise),M04(spindle counter clockwise),M05(spindle stop).They are all mode used to control spindle.The mode of same kind are categorized into one mode group.At any time it must be one of them,and there is only one of them.The original chosen mode is called mode origin.In the above mode group,M05 is such a mode origin 。

Suspending Mode (destroying mode)**:** It is instruction which can turn mode instruction into mode origin or destroy the mode.Such as M20(program ending instruction),meaning the end of operation and returning to original status.

None Mode instruction : It is the instruction which has no function to store,and only works in the segment of program.

4.2 General description of program

G02, T02, H02, D02, M02, S04, F04, X-043, Y-043, Z-043, A-043, I-043, J-043, K-043, L04, P4, R043。

Note 1:“-”means this data can be use.

Note 2:In front of the numeral is 0, indicated this data only write the effective data。

Note 3:The digital presentation is a figure, when is two, top digit expression integer figure biggest figure, after low position expresses decimal point most imperial throne.

4.3 Program instruction

Introduce all the functions and using method of instruction code in this system.

4.3.1 Functional meaning of address symbol,data list

Functions	Address	meaning	Data range
-----------	---------	---------	------------

Document No.		File name of machining workpiece	0-9、A-Z
Program segment No.	N	No. of program segment	0000-9999
Preparation function	G	Content and mode of designated instruction operation	00-99
Auxiliary function	M	Auxiliary operation instruction	00-99
Tool chosen	TDH	No.of Tool.	01-99
Tool compensation	H D	The length compensates No.of the radius compensates of the parameter	1- 4
Spindle function	S SP	The spindle speed; spindle localization	00-99999
Cutting speed	F	Speed per minute	1-3000mm/min
Coordinates character	X Y Z A(B/C/ U/V/W)	The coordinates value of X Z and 4th axes.	±9999.999mm
Core coordinates	I J K	X Z axes and Z axes core coordinate increment value	±9999.999mm
Step length	R	Circular arc radius	0.001-999.999mm
Delay time	P.X	Delay time of designated delay	0.001-99.999s
Program entrance	P	Entrance of calling program name	0000-9999
Repeat times	L	Times of cycle or subprogram calling	1-9999
Line skip	/	Not to carry out when “/” is in front of program line	Other parameter P12 can disable the function

4.3.2 Program instruction

Table 1 G Instruction-code and functions

G code	function
G00	Fast positioning
G01	The straight-line interpolation
G31	No alarm when checking skip
G311	Alarm when checking skip

G02	Interpolation along the circle interpolation/the spiral line interpolation CW: The spiral motion spiral line interpolation makes up the 2 circular arcs insert makes up the axis synchronization migration other axes. The instruction method only is simply adds on is not the circular arc inserts makes up the axis the shifting shaft	
G03	The counter circle interpolation/ the spiral line interpolation CCW	
G01(G00)X I	Beveling automatically	
G01(G00)Y I	Beveling automatically	
G01(G00)Z I	Beveling automatically	
G01(G00)X R	Smoothing automatically	
G01(G00)Y R	Smoothing automatically	
G01(G00)Z R	Smoothing automatically	
G04	Delay	
G15	Polar coordinate instruction cancellation	
G16	Polar coordinate instruction: The polar coordinate (radius and angle), the angle to is anti-clockwise changes of the first axis positive direction on the plane, but the negative direction is clockwise changes .	
G17	Choose the Xp Yp plane	Xp: X axis or its parallel axis Yp: Y axis or its parallel axis Zp: Z axis or its parallel axis
G18	Choose the Z X plane	
G19	Choose the Y Z plane	
G20	Inch input(British system)	
G21	Millimeter input(Metric system)	
G28/G281/G282/G283/G284	Go to machine zero point	

M882, M883	Drop set of Z axis automatic tool setting
M884-M887	Aromatically finding edge of X, Y axis
M880	Set tool automatically
G30/G301/G302/G303 /G304	Go to coordinate zero point
G26	ZXY axis go to program original point
G25	Memory current coordinate of X Y Z A
G261	X axis go to program original point
G262	Y axis go to program original point
G263	Z axis go to program original point
G264	A axis go to program original point
G61/G611/G612/G613 /G614	Back to the memory point by G25
G40	Cancel tool radius compensation
G41	tool radius compensata(left)
G42	tool radius compensata(right)
G43	Positive tool length compensation
G44	Negative tool length compensation
G49	Cancel tool length compensata
G45	Tool offset adding
G46	Tool offset subtract
G47	Double tool offset adding
G48	Double tool offset subtract
G37	Cancel scale zoom
G36	Enable scale zoom : format : G36 X_Y_Z_R_
G12	Cancel programmable mirror
G11	Enable programmable mirror
G50/G52	Set coordinate system: the programmer in work coordinate system is easy program, subcoordinate system is permitted in workpiece coordinate system.
G53	Choose machine coordinate system

G54.1/G54.48	Choose work coordinate 1	Note: These six work coordinates are saved in CNC , user may choose one of them
G55	Choose work coordinate 2	
G56	Choose work coordinate 3	
G57	Choose work coordinate 4	
G58	Choose work coordinate 5	
G59	Choose work coordinate 6	
G60	exactitude stop positioning	
G64	Continue path work	
G68	rotate coordinate,format: G17 } G18 } G68 a-b- R-; R:Angle G19 }	
G69	Cancel rotate coordinate	
G73	Drill deep hole loop: intermittent feed, rapidly back.	
G80	Cancel cycle mode/cancel external operation	
G81	Drill cycle: cutting feed, boring cycle or external operation, rapidly back	
G82	Chip removal drill cycle or reverse boring cycle: cutting feed, stop tool at the bottom of hole, rapidly back.	
G83	Drill small deep hole cycle: intermittent feed, rapidly back.	
G85	Boring cycle:cutting feed, back cutting feed	
G86	Boring cycle:cutting feed, stop spindle at the bottom of hole, rapidly back.	
G89	Boring cycle: stop tool at the bottom of hole, back cutting feed	
G74	Left Tap cycle	
G84	Right Tap cycle	
G90	Absolute program	
G91	Incremental program	

G98	Go back to original point: used in final drill
G99	Go back to R point : used in the first drill
G22	Program cycle instruction
G800	Cancel Program cycle instruction

Table 2 M code and function

Spindle	M03	Spindle CW	M7053/M7054 P xxxx; It will stop after spindle CW or CCW for a time, the time is determined by "P". Unit: Millisecond. Example: M7053 P2000; Means it will delay 2 seconds to stop spindle.
	M04	Spindle CCW	
	M05	Stop Spindle	
	M203	The 2 nd spindle CW	
	M204	The 2 nd spindle CCW	
	M205	Stop 2 nd spindle	
Cooling	M08	Turn on cool	
	M09	Turn off cool	
Chuck	M10	Tighten tool	
	M11	Loosen tool	
Huff	M58	Turn off huff	Controls M59 signal
	M59	Turn on huff	
Lubrication	M32	Turn on lubricate	Controls M32 signal
	M33	Turn off lubricate	
User-defined	M79	User self-defined 7 output turn on	Double signal output
	M78	User self-defined 7 output turn off	
User-defined output	M61	User self-defined2 output turn on	Controls M61 signal
	M60	User self-defined2 output turn off	
	M63	User self-defined3 output turn on	Controls M63 signal
	M62	User self-defined3 output turn off	
	M65	User self-defined4 output turn on	Controls M65 signal
	M64	User self-defined4 output turn off	
	M67	User self-defined5 output turn on	Controls M67 signal
	M66	User self-defined5 output turn off	

	M69	User self-defined6 output turn on	Controls M69 signal
	M68	User self-defined6 output turn off	
	M71	User self-defined7 output turn on	Controls M71 signal
	M70	User self-defined7 output turn off	
	M75	User self-defined8 output turn on	Controls M75 signal
	M74	User self-defined8 output turn off	
Spindle shifting	M41	SP Speed first gear	Output S01,S02,S03,S04, to adjust analog voltage of spindle
	M42	SP Speed second gear	
	M43	SP Speed third gear	
	M44	SP Speed fourth gear	
User-defined input	M12	Check M12 input valid	To skip when conditions are tenable Example: M12 P120 Program skips to 120th line to execute.
	M13	Check M12 input invalidate	
	M14	Check M14 input valid	
	M15	Check M14 input invalidate	
	M16	Check M16 input valid	
	M17	Check M16 input invalidate	
M18	M18	Check M18 input valid	
	M19	Check M18 input invalidate	
M28	M28	Check M28 input valid	
	M29	Check M28 input invalidate	
M22	M22	Check M22 input valid	
	M23	Check M22 input invalidate	

	M24 M25	Check M24 input valid Check M24 input invalidate	
Subprogram	M97 M98 M99	Program skip Invoke subprogram Cancel invoke subprogram	L=1-99 P is the line number of transferring program
Program controlling	M87	Number of workpiece plus 1	other parameter P10=0 is set not to symptotomatically plus 1, instruction M87 to make workpiece number plus 1
	M00	Suspend program	
	M01	Suspend program,input M22 effective suspend Program is over	
	M02	Program end	
	M30	M05,M09 program is over	
	M20	Program is over, automatic repeat run the program according to the parameter which set the running times, be used for the debugging	
Speed of spindle	S SS	Set speed of the first spindle Set speed of the second spindle	S=0-99999 SS=0-99999

<p>Read the position of absolute motor</p>	<p>M500 M501 M502 M503 M504</p>	<p>M500: read absolute motor position of all the feeding axis and reset the current machine coordinate. M501: read absolute motor position of X axis and reset the current machine coordinate. M502: read absolute motor position of Y axis and reset the current machine coordinate. M503: read absolute motor position of Z axis and reset the current machine coordinate. M504: read absolute motor position of the fourth axis and reset the current machine coordinate.</p>	
<p>Clear workpiece coordinate</p>	<p>M312 M313 M314 M315 M316 M317 M318 M319 M320</p>	<p>M312:Clear C axis workpiece coordinate M313:Clear Xs axis workpiece coordinate M314:Clear Ys axis workpiece coordinate M315:Clear A axis workpiece coordinate M316:Clear B axis workpiece coordinate M317:Clear X axis workpiece coordinate M318:Clear Y axis workpiece coordinate M319:Clear Z axis workpiece coordinate M320:Clear all axis workpiece coordinate</p>	

<p>Clear machine coordinate</p>	<p>M412 M413 M414 M415 M416 M417 M418 M419 M420</p>	<p>M412:Clear C axis machine coordinate M413:Clear Xs axis machine coordinate M414:Clear Ys axis machine coordinate M415:Clear A axis machine coordinate M416:Clear B axis machine coordinate M417:Clear X axis machine coordinate M418:Clear Y axis machine coordinate M419:Clear Z axis machine coordinate M420:Clear all axis machine coordinate</p>	
<p>Bus driver instruction</p>	<p>M133 M135</p>	<p>M133:driver runs with specified speed (multiple of 30) Driver parameter P30=0 means constant speed, P30=1 means weave, referring to axis parameter. M135: enable specified driver</p>	<p>Example: M133 X300; M135 Z0: turn off Z axis driver; M135 X1:enable X axis driver;</p>

M1xxx: waiting for auxiliary relay effective, for example, M1076 means wait for M76 on;

M2xxx: waiting for auxiliary relay ineffective, for example, M1078 means wait for M76 off;

M3xxx: set auxiliary relay effective, for example, M3330 means set M330 on;

M4xxx: set auxiliary relay ineffective, for example, M4331 means set M331 off;

M38xx: set output effective, for example, M3809 means set Y09 on;

M48xx: set output ineffective, for example, M4807 means set Y07 off;

M18xx: waiting for input point Xxx effective then go to next, for example, M1809 means waiting for X09 effective, then go to next step.

M28xx: waiting for input point Xxx ineffective then go to next, for example, M2807 means waiting for X07 ineffective, then go to next step.

M18xx Pxx: check input point Xxx effective then go to next, otherwise skip to Pxx line. for example, M1809 P234 means if X09 effective, then go to next step, if X09

ineffective, skip to P234 line.

M28xx Pxx: check input point Xxx ineffective then go to next, otherwise skip to Pxx line. for example, M2807 P456 means if X07 ineffective, then go to next step, if X07 effective, skip to P456 line.

4.4 Programme instruction and usage

4.4.1 Programme convention

(1). Multiply instruction exist in a segment simultaneously: one program line allows multiply instructions in order to reduce the lines, but the same group of instruction can not share one segment.

(2). Within a program segment, instruction and parameters can be arranged optionally.

Such as: M03 G01 X20 Y-30 can be written: G01 Y-30 X20 M03

(3). No repeat of instruction within a program segment.

(4). It can't be irrelative parameters and operation in a segment.

(5). "0" before a instruction is allowed to delete, such as: G01 G03 can be written as G1 G3.

(6). The command of optional point, line start or that after tool changing instruction must be programmed by absolute coordinates.

(7). Non mode command only in specified program line is effective, such as: G04.

(8). Mode instruction is always effective before appearing the same instruction.

For example: N0000 G01 X300 F100; G01 instruction

N0001 X260 ; G01 instruction

N0002 G00 Z200 ; G00 instruction, G01 is invalid

4.4.2 Instruction of G function

(1) Choose instruction of coordinate system.(G53/G54/G55/G56/G57/G58/G59)

Format: G53 (G54/G55/G56/G57/G58/G59) Mode instruction

G53 machine coordinate

G54 work coordinate 1

G55 work coordinate 2

G56 work coordinate 3

G57 work coordinate 4

G58 work coordinate 5

G59 work coordinate 6

G53 machine coordinate is decided by machine reference point. The default coordinate is G53. Suggest not to adjust the value of G53, all the workpiece coordinate will have offset.

G54/G55/G56/G57/G58/G59 work coordinate have offset relative to machine coordinate which can be set in parameter.

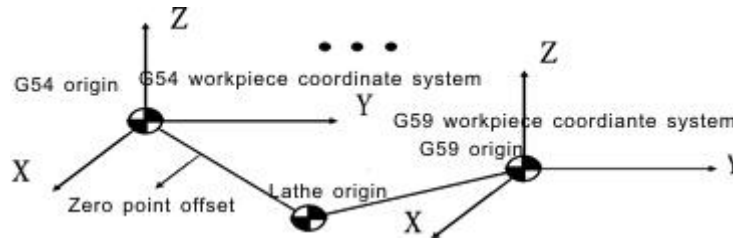

Example: G00 G54 X50 Y60 Z70

Move to X50 Y60 Z70 of G54 with speed of G00.

(3) Coordinate system instruction

Set local coordinate system when programming in workpiece coordinate system is to programme easily. G50 is used to set workpiece coordinate system, and G52 is used local coordinate system setting.

Format:G52 X_ Y_ Z_ ; Set local coordinate system (Mode)

G52 X0 Y0 Z0; Cancel local coordinate system

Use G52 to set local coordinate system in lathe coordinate system(G53) or workpiece coordinate system(G54~G59). The origin of local coordinate system is set by X_ Y_ Z_.

Once local coordinate system is done, the instructions by G90 will move in the local coordinate system. G50/G52 are used to specify the new zero point, changing position of local coordinate system. Local coordinate system should share the same zero point with workpiece coordinate system in order to cancel local coordinate and specify coordinate in workpiece coordinate system.

Local coordinate system setting does not change the workpiece coordinate system and machine coordinate system. When using the G52 instruction to set workpiece coordinate system, if it is not the instruction of all the axis coordinate value, the local coordinate system of non-specified axis will remain unchanged .Use the absolute mode to specify motion instruction next theG50/G52 program segment .

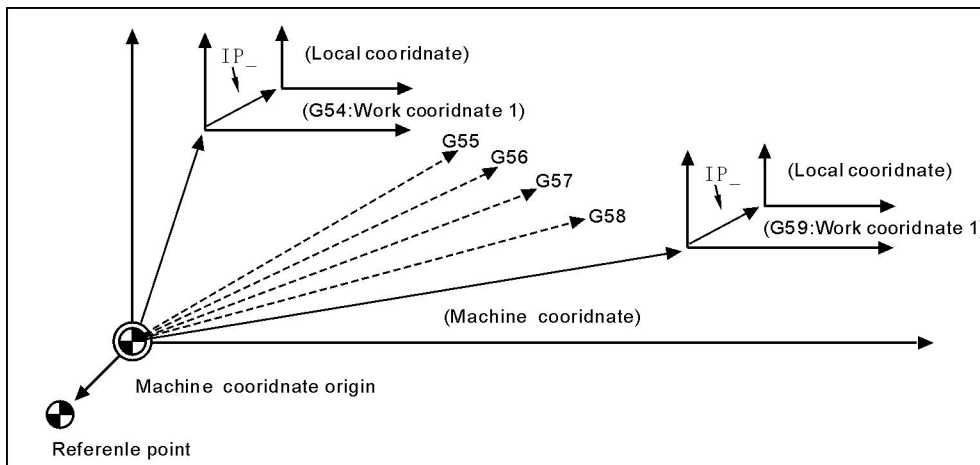

(3) Program method(G90/G91)

Two methods to move tools: Absolute value instruction and incremental value instruction. Programme coordinate value of end point with absolute value; while programme incremental value of moving distance with incremental value. G90 and

G90 are respectively used to point out the coordinate with absolute value or incremental value.

Format: G90 (Mode,initial) ;Absolute
G91 (Mode) ;Increment

Pay attention:The rotating axis use nearest calculation and move accordingly when using absolute coordinate to programme, using programming calculation to work when using relative coordinate to programme.

(4) Select Plane(G17/G18/G19)

Format: G17 (Mode, Original) ;Set XY Plane
G18 (Mode) ;Set ZX Plane
G19 (Mode) ;Set YZ Plane

Used to point out arc interpolation plane.

Note: this instruction does not produce motion.

(5) Rapid motion(G00)

Tool moves to workpiece coordinate system by instruction according to G00 speed in parameter.

In absolute method, use endpoint coordinate to program;

In incremental method, use moving distance of tool to program.

Format: G00 X- Y- Z- A- (Mode, original)

Note: X, Y, Z, A, means motion axis.The data point out motion distance and direction by absolute or incremental method.

In G00 instruction, each axis moves to endpoint separately with the specified speed. Each axis stops moving till the aim point, and next axis keep moving to instruction position. All of axis can move simultaneously by other parameter P9, D6=0 means linked moving.

Moving speed is determined by Speed parameter of G00.

(6) Line interpolation(G01)

Used for single axis motion or 2,3,4 axis interpolation processing..

Format: G01 X_ Y_ Z_ A_ F_ (Mode)

Note: X, Y, Z, A means motion axis.The data point out motion distance and direction by absolute or incremental method.Motion speed is determined by F word. The F instruction is mode.

The feeding speed of F in G01 can be adjusted by feeding override on the panel, the range is 0%~150%.

G01 instruction also can be written G1.

(7) Arc interpolation(G02/G03)

In the program plane, G02 clockwise and G03 counter-clockwise are used to execute arc interpolation processing

Format: $.G17 \left\{ \begin{matrix} G02 \\ G03 \end{matrix} \right\}_{X_Y_} \left\{ \begin{matrix} I_J_ \\ R_ \end{matrix} \right\}_{F_}$;XY plane(Mode)

$G18 \left\{ \begin{matrix} G02 \\ G03 \end{matrix} \right\}_{X_Z_} \left\{ \begin{matrix} I_K_ \\ R_ \end{matrix} \right\}_{F_}$;ZX plane(Mode)

$G19 \left\{ \begin{matrix} G02 \\ G03 \end{matrix} \right\}_{Y_Z_} \left\{ \begin{matrix} J_K_ \\ R_ \end{matrix} \right\}_{F_}$;ZY plane(Mode)

Note: Arc interpolation must point out interpolation plane, the X、Y、Z word point out the arc end coordinate value, I、J、K is incremental value from original point(speed parameter P47 =+4 means endpoint) of X, Y, Z axis to center point. In another word, let the original point be zero point, and if the center is in the forward direction of original point, the value will be positive, if the center is in the backward direction of original point, the value will be negative. I J K are used to define center point coordinate. Besides, R program is also used to define center point coordinate, the R is negative when arc angle is over 180 degree, but it is not applicable for whole cycle. The trend of arc goes from positive to negative direction that is perpendicular to arc interpolation plane in right-handed rectangular coordinates.

The arc track of different arc interpolation plane as follow:

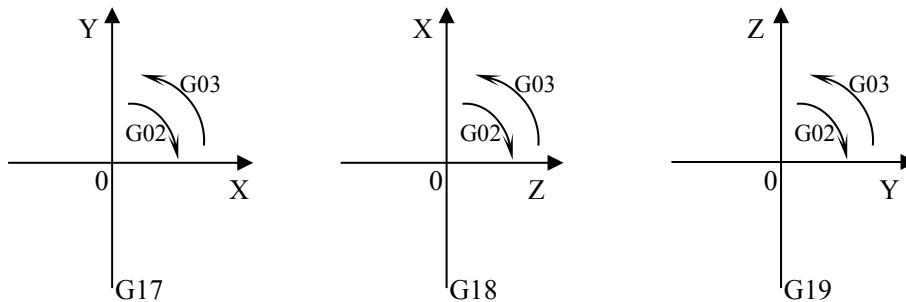

I J K are used to define the arc center position, the value behind I J K are vector component from original point to arc center. I J K must be marked as positive or negative according to directions. I J K can be omitted, then endpoint and original point is the same one, and the arc will be whole cycle when center is specified by I J K, it will always be incremental as following no matter G90 or G91.

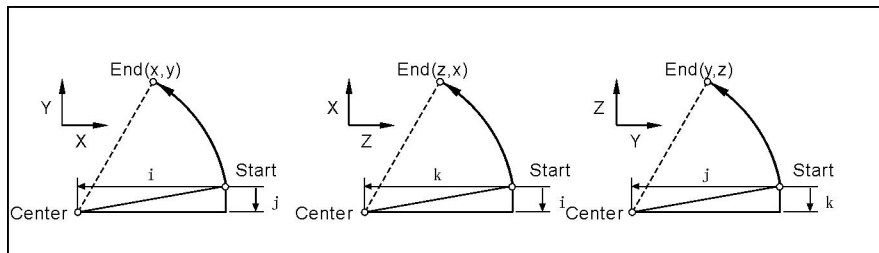

The arc interpolation speed is determined by F word.
 Attention: I, J, K and R are the non-modality instruction.
 Demonstration:

1) absolute programming	
N0000 G92 X200 Y40 Z0;	set start point absolute coordinate;
N0010 G90 G03 X160 Y40 I-20 J0;	count-clockwise arc;
N0020 G02 X120 Y40 R20;	clockwise arc;
N0030 G02 X120 Y40 R20;	whole cycle;
N0040 G26 M02;	end and back to start point.
2) Relative programming	
N0000 G91 G17 G03 X-40 Y0 R20 F300;	count-clockwise arc;
N0010 G02 X-40 Y0 R20;	clockwise arc;
N0020 G02 X0 Y0 R20;	whole cycle;
N0030 G26 M02;	end and back to start point.

Two methods have the same result.

(8) Spiral interpolation (G02/G03)

Spiral interpolation means arc interpolation adding another linear-axis interpolation, F instruction defines arc interpolation speed. therefore, the feed speed of line interpolation axis is as follow:

$$F \times \frac{\text{Lengthen of line axis}}{\text{Lengthen of arc}}$$

Format : G17 $\left\{ \begin{matrix} G02 \\ G03 \end{matrix} \right\} X_Y_ \left\{ \begin{matrix} I_J_ \\ R_ \end{matrix} \right\} Z_F_$;XY plane(Mode)

G18 $\left\{ \begin{matrix} G02 \\ G03 \end{matrix} \right\} X_Z_ \left\{ \begin{matrix} I_K_ \\ R_ \end{matrix} \right\} Y_F_$;ZX plane(Mode)

G19 $\left\{ \begin{matrix} G02 \\ G03 \end{matrix} \right\} Y_Z_ \left\{ \begin{matrix} J_K_ \\ R_ \end{matrix} \right\} X_F_$;YZ plane(Mode)

Spiral line enhancement: screw pitch K(J or I) can be inserted into program to process multi-turn spiral line.

G02(G03) X__ Y__ I__ J__ F__ Z__ K__ (G17, K screw pitch, unit:mm);

G02(G03) X__ Z__ I__ K__ F__ Y__ J__ (G18, J screw pitch,unit:mm);

G02(G03) Y__ Z__ J__ K__ F__ X__ I__ (G19, I screw pitch, unit:mm);

G02(G03) X__ A__ I__ J__ F__ Z__ K__ (G177/XA plane, K screw pitch, unit:mm);

G02(G03) Z__ A__ K__ I__ F__ Y__ J__ (G188/ZA plane, J screw pitch, unit:mm);

G02(G03) Y__ A__ J__ K__ F__ X__ I__ (G199/YA plane, I screw pitch, unit:mm);

The cutting tool radius compensates only carries on to the circular arc, cutting tool bias and the cutting tool length compensate cannot be inserted in the segment of spiral line program.

In the spiral interpolation section, cannot use tool length and radius compensation.

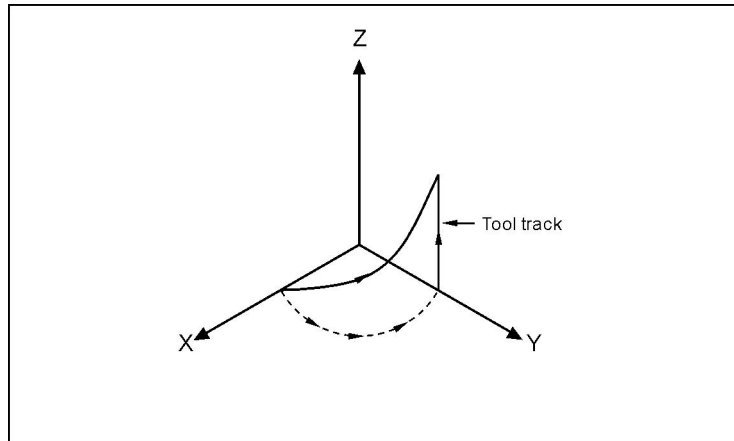

```
N0001 G90 G17 G54
N0002 G01 X20 Y0 Z0 F600
N0003 G03 X0 Y20 R20 Z15 F180
.....
```

(9) Three dimension space arc instruction(G06)

Format: G06 X__ Y__ Z__ I__ J__ K__ F__

Function: if center point and radius of three-dimension space arc are unknown, but the coordinates of three points in arc are known, then G06 can be used to find direction of arc by the middle point between start point and endpoint.

Definition of instruction: G06 is mode G code;

I: relative coordinate value(X direction) of middle point relative to start point on arc(radius value and with direction);

J: relative coordinate value(Y direction) of middle point relative to start point on arc(with direction);

K: relative coordinate value(Z direction) of middle point relative to start point on arc(with direction).

Attention:

- 1) Middle point: refers to any point in the arc except for start point and endpoint;
- 2) if there are three col-linear points, it will alarm;
- 3) when I is omitted, it defaults to I=0; when K is omitted, it defaults to K=0; when J is omitted, it defaults to J=0. but if I,J, K are omitted at the same time, it will alarm.
- 4) IJK of G06 is just similar to the displacement value IJK of center point relative to start point coordinate in G02/G03.
- 5) G06 cannot be used to process whole cycle.
- 6) the instructions requires a lot of math operation, therefor it works perfect in bus type controller, while it may not work fluently as Bus type in other type controllers.

Example:

```
G0 X10 Y28 Z10
G06 X30 Y98 Z10 I5 J-6 K-5 F100
X130 Y198 Z120 I55 J-86 K-65
G0X0Z0
```

M02

(10) Delay instruction(G04)

Used to delay a certain time for the requirements of processing technique.

Format: G04 P_ ;or
G04 X_ ;or
G04 U_ ;

Function:Every axis is stop and mode instruction is still working when execute this instruction, after delaying the specified time to execute the next program segment.

Instruction introduction:

- a.The unit of P delay time is ms(Millisecond).
- b.The unit of X and U delay time are S (second) .
- c.Example:

G04 X1; delay 1s.
G04 P1000; delay 1s.
G04 U1; delay 1s.

d.Special application:G04 can be accurate stop instruction, such as processing corner kinds of workpiece, it appears over cutting sometimes, if use G04 instruction around the corner, it will eliminate the over cutting.

Example as follows:

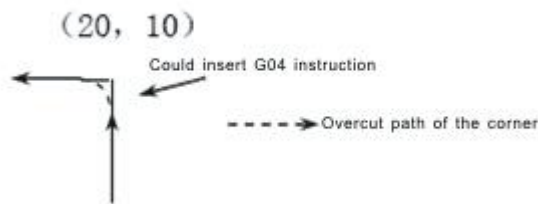

```

Program: ... ..
N150 G01 X20 Z10 F100;
N160 G04 P150; (Clear the over cutting)
N170 G01 W-10;
.....

```

Pay attention: Set No.21 parameter in “N”(processing) parameter to clear the over cutting.

(11) Mirror instruction(G11/G12)

In order to decrease program codes, be used for machining symmetry workpiece.

Format: G11 X_ Y_ (Z_ X_) (Y_ Z_)(mode)
 according to XYZ symmetry axis
G12 (mode, original) ;Cancel Mirror。

Note: mirror processing perform symmetric machining of the axis by changing feeding direction of axis. The axis changing direction is determined by address character of current interpolation plane G17(X_ Y_); G18 (Z_ X_); G19(Y_ Z_). the

value behind X_ Y_ Z_ is coordinate of current workpiece coordinate system.

In programmable mirror mode, such instruction about back reference point as G26,G61,G28,G30 and instruction about changing coordinate system like G52,G53/G59 cannot be employed. These G code cannot be specified until cancel the programmable mirror mode.

For example:

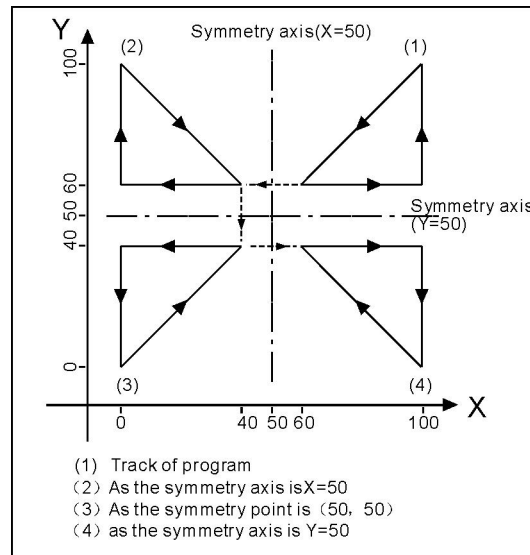

The mirror procedure gives an example:

Sub program

KG11

N10 G00 G90 X60.0 Y60.0;

N20 G01 X100.0 F100;

N30 G01 Y100.0;

N40 G01 X60.0 Y60.0;

N50 M99;

Main program

N10 G00 G90;

N20 M98 PKG11;

N30 G11 X50.0;

N40 M98 PKG11;

N50 G11 X50.0 Y50.0;

N60 M98 PKG11;

N70 G11 Y50.0;

N80 M98 PKG11;

N90 G12;

N100 M02

(12) Proportions scale instruction(G36/G37)

Used for unchanging the processing program, to process proportionally reduced or enlarged workpiece. Programming shape is magnified and reduced (scaling), use X_, Y_ and Z_ to specify scaling center. If an axis is not specified, the axis will not carry

out scaling. The number behind the X_Y_Z_ is the coordinate of current workpiece coordinate system.

```

Format: G36 X_Y_Z_R_ (mode)      ;Carry out
        G37 (mode, original)      ;Cancel

```

Note: behind R is the scale coefficient is

For example:

P1` P2` P3` P4` magnify to P1 P2 P3 P4, $R=P0P4'/P0P4$. When P1 P2 P3 P4 reduce to P1` P2` P3` P4`, $R=P0P4/P0P4'$. So: $R<1$ when magnifying, $R>1$ when reducing, $R=1$ can be default.

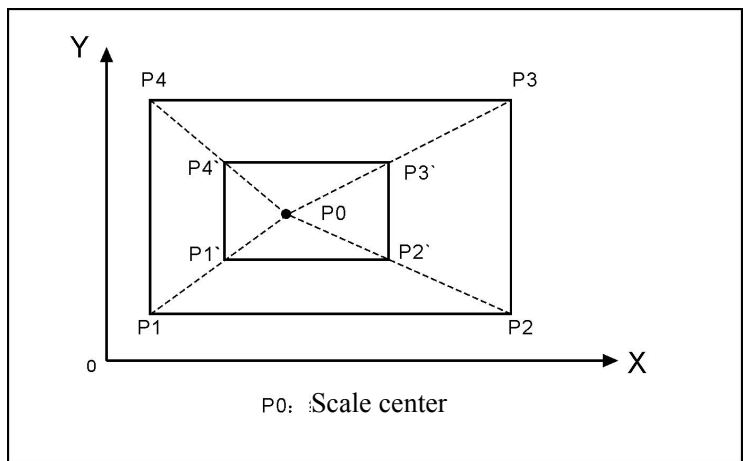

In the proportions scale section, cannot use tool length and radius compensation:

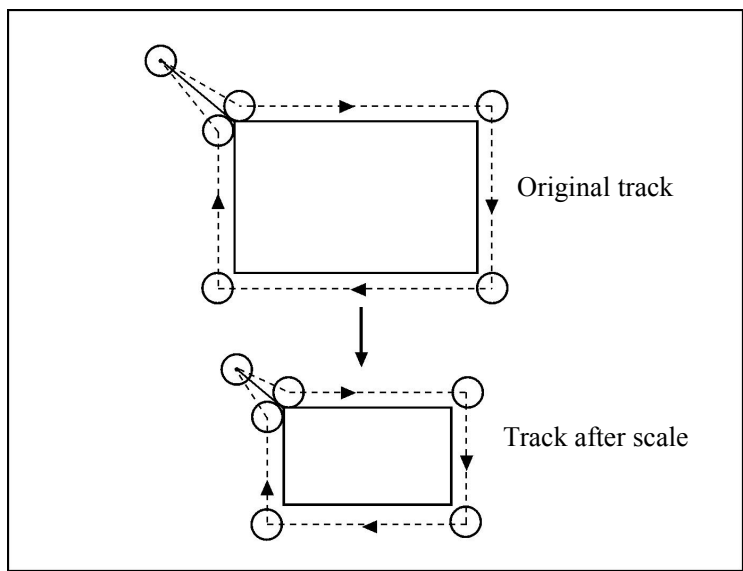

(13) Coordinate rotate(G68/G69)

Programming shape can rotate, the rotating instruction can make workpiece rotate for specified angle. Anyway, if the shape of workpiece is comprised of many same graphics, the graphics unit can be compiled to subprogram, then the subprogram is on tap for rotation instruction of main program. This can simplify the programming, saving storage space.

```

Format:  G68 X- Y- R- (mode) ; enable
         G68 Z- X- R- (mode) ; enable
         G68 Y- Z- R- (mode) ; enable
         G69 (mode, original) ; disable

```

Note: The (G17)X-Y- or (G18)Z-X- or (G19) Y-Z- behind G68 is used for pointing out rotate center.

R word is used for pointing out rotate angle, unit is °(degree), the value behind X_Y_Z_ is coordinates of current coordinate system;

positive R means rotate CCW;

Negative R means rotate CW.

Example:

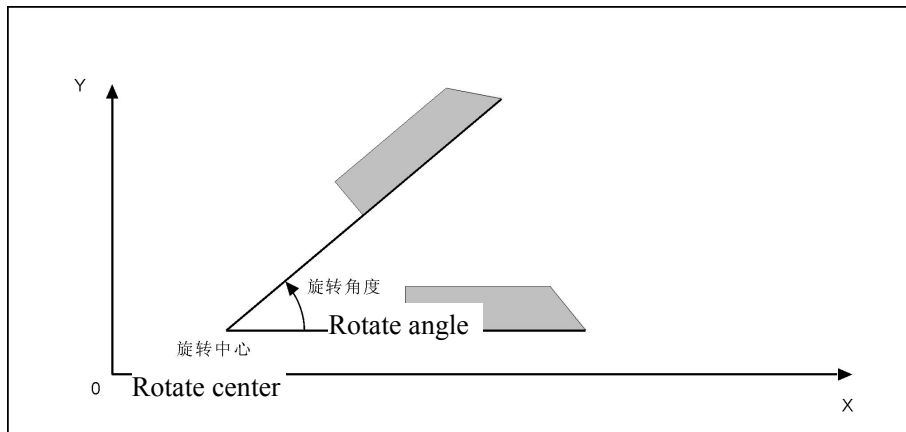

To specify plane and select code(G17 G18 or G19) before the G68 code program segment, select the code cannot be specified in the mode of rotating coordinate system. Cancel the mode G69 code must occupy a program segment separately. After rotating the coordinate system to carry out tool radius compensation, tool length compensation, tool offset and other compensation.

In the mode of rotating coordinate system, the G code (G28 G26 G31 G30 etc) which is related with backing to the home point and those related with the the G code (G52, G54/G59) of coordinate system cannot be specified, if need these G codes, must specify after canceling coordinate rotation mode. The first moving instruction must use absolute value instruction after the coordinate system rotation cancel G69, if use incremental instruction, it will not to carry out correct motion.

Example:

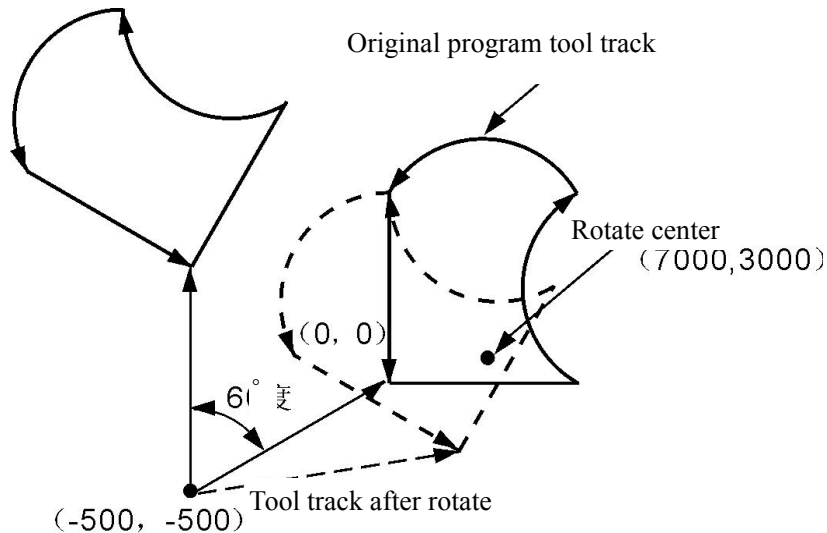

```

N1 G92 X-500Y-500F20000 G17;
N2 G68 X700Y300R60;
N3 G90 G01 X0 Y0 F20000;
N4 G91 X100
N5 G02 Y100 R100
N6 G03X-100I-50J-50;
N7 G01Y-100
N8 G69
N9 G90 X-500Y-500
N10 M02;
    
```

(14)Return reference point(Zero point)

(G28/G281/G282/G283/G284/G301/G302/G303/G304)

Return Reference instruction means tool go to reference point according to appointed axis.

Format:	G28 X(U)_ Y(V)_ Z(W)_ A_ B_ ;ZXYAB return to reference
G281	;only X return to reference
G282	;only Y return to reference
G283	;only Z return to reference
G284	;only A return to reference
G285	;only B return to reference
G301	;X axis return to zero
G302	;Y axis return to zero
G303	;Z axis return to zero
G304	;A axis return to zero

Pay attention: Should clear tool radius compensation and tool length

(15)Tool length compensation instruction(G43/G44/G49)

The difference between programming tool length and actual using tool length can be compensated with this function so that not to adjust the program. Use G43 or G44 to specify the direction of offset, import the corresponding H code address to select

tool length offset value from the offset table.

On the plane G17(XY), length compensation applies to Z axis, so tool should be installed in Z axis;

On the plane G18(ZX), length compensation applies to Y axis, so tool should be installed in Y axis;

On the plane G19(YZ), length compensation applies to X axis, so tool should be installed in X axis.

Format:

- G43 H_ ;Add tool length compensate。
- G44 H_ ;subtract tool length compensate。
- G49 or H0 ;cancel tool length compensate.

Note:tool length compensation refers to add or subtract the value of tool length compensation on Z axis or other axis. Invoking number is H1-H99. compensation value of parameter starts from the tool position before compensation.

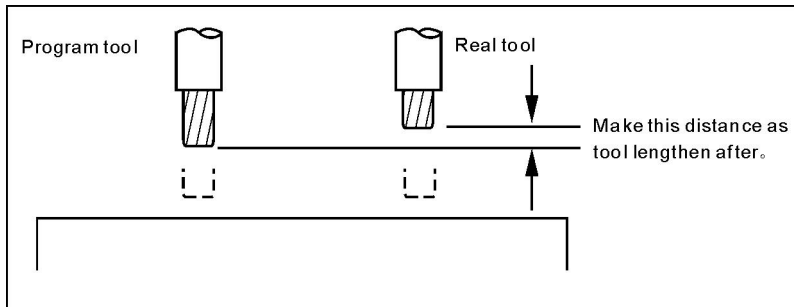

Example: N0000 G43 H2 X10 (H2 value is 5)
 N0010 G44 H3 X20 (H3 value is 10)

Executing first section,tool length add 5. Executing second section,tool length subtract 10(real running is 10+5=15), backing to original position.

(16)Offset of tool radius instruction(G45/G46/G47/G48)

Used for processing groove of the workpiece, programming according to the size of workpiece drawing, the instruction line with the one of this set of instruction, then it can work out correct production in different tool radius.

- Format:
- G45 T_ ;Add one radius。
 - G46 T_ ;subtract one radius。
 - G47 T_ ;Add two radius。
 - G48 T_ ;subtract two radius。

Note:The instruction of increasing or decreasing the tool radius is increasing or decreasing one or two tool radius parameter values with T number in the execution. And be used with XY (G17) plane of the G00, G01, G02, G03 instruction. Can not be used with tool radius compensation instruction (G41,G42)

Increase or decrease one or two tool radius in the direction of axis for G00 and G01.

For G02 and G03 is increasing or decreasing one or two tool radius in the direction of arc radius.

G45/G46/G47/G48 are non-modal instructions.

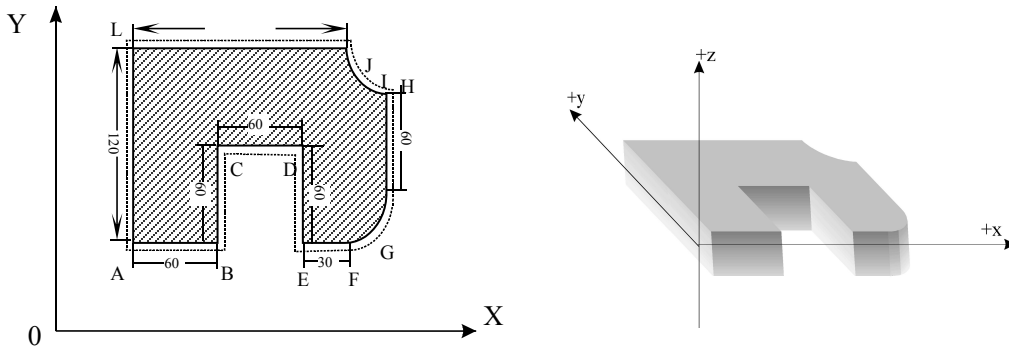

Program as follows:

```

N0000 G01 Z-20 F400 G91 ; Z point starts
N0010 G46 T01 X55 Y55 ; Point location to A point, X and Y axis both
decrease one tool radius(T01)
N0020 G47 G01 X60 F200 ; A-B X axis increase two tools radius
N0030 Y60 ; B-C length not change
N0040 G48 X60 ; C-D X axis decrease two tools radius
N0050 Y-60 ; D-E length not change
N0060 G45 X30 ; E-F X axis increase one tools radius
N0070 G45 G03 X30 Y30 R30 ; F-G CCW radius increase one tool radius
N0080 G45 G01 Y60 ; G-H Y axis increase one tool radius
N0090 G46 X0 ; H-I Move for one tool radius along the
negative direction of X axis
N0100 G46 G02 X-30 Y30 R30 ; I-J CW radius decrease one tool radius
N0110 G45 G01 Y0 ; J-K Move for one tool radius along the
positive direction of Y axis

N0120 G47 X-150 ; K-L X axis increase two tools radius
N0130 G47 Y-120 ; L-M Y axis increase two tools radius
N0140 G46 X-55 Y-55 ; M-N X and Y axis both decrease one tool
radius
N0150 G26 ; Program backs to the starting point to end
N0151 M02
    
```

The relationship between Plus(+), Minus(-) and tool radius in above example is addition of term of the same sign, subtraction of term of different sign. Coordinate can be zero, used to specify coordinate axis, run length is 1 or 2 radius. The direction is specified by signs of instruction and radius.

(17) Tool radius compensate instruction(G40/G41/G42)

When the tool is moving, tool track can offset a radius. In order to offset a radius, CNC establish offset vector whose length equal tool radius. Offset vector

is vertical to tool track。 Completed machining, it needs to cancel tool radius compensation。

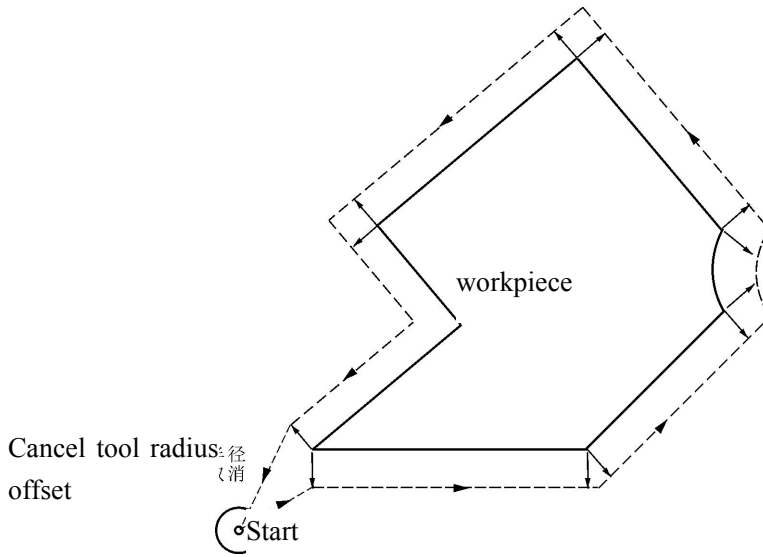

Format: G40	(mode, original)	;Cancel compensation。
G41 T—	(mode)	;tool locate to Left offset of workpiece
G42 T—	(mode)	; tool locate to Right offset of workpiece。

Note:

Left or right side of G41/G42 is following in the direction of cutting, tool is in the left or right of workpiece. tool radius is invoked by T1-T99. execution of offset stars from the line of G41/G42. It will generate transition line at sharp corner, in order to transit from the tool radius offset vector in the end of last segment to the offset vector in the beginning of next segment. Tool offset vector refers to describing value and direction of tool offset.radius vector is radius of tool. For arc, its direction is the radius direction. And for line, it direction is vertical direction of line.

Tool radius compensation establish and cancel have two type: A type and B type, which can set in other parameter。 Furthermore, Tool radius compensation establish and cancel must be executed in line section。

For example:

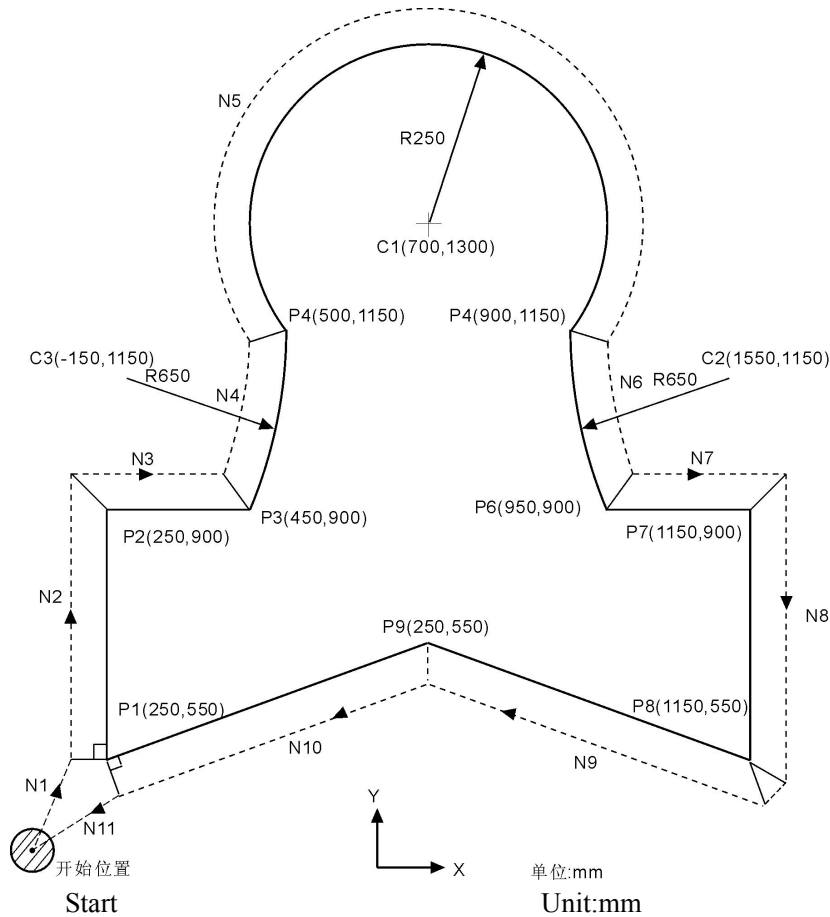

```
G54 X0 Y0 Z0;.....
N1 G90 G17 G00 G41 T15 D2 X250.0 Y550.0; establish compensation
N2 G01 Y900.0 F150; ..... from P1 to P2
N3 X450.0; .....from P2 to P3
N4 G03 X500.0 Y1150.0 R650.0; .....from P3 to P4
N5 G02 X900.0 R-250.0; .....from P4 to P5
N6 G03 X950.0 Y900.0 R650.0; .....from P5 to P6
N7 G01 X1150.0; .....from P6 to P7
N8 Y550.0; .....from P7 to P8
N9 X700.0 Y650.0; .....from P8 to P9
N10 X250.0 Y550.0; .....from P9 to P1
N11 G00 G40 X0 Y0; ..... cancel compensation
```

(18) Program circulation instruction (G22--G800)

G22 is program circulation instruction, G800 is an instruction to end circulate. But G22 must be used with G800 for repeated processing. L means circulation times, the range is 1-99999.The circulation instruction can nest.

Format:	G22 L2		;begin
	:	}	;circulating
	:		
	:		
	G800		;end

For example

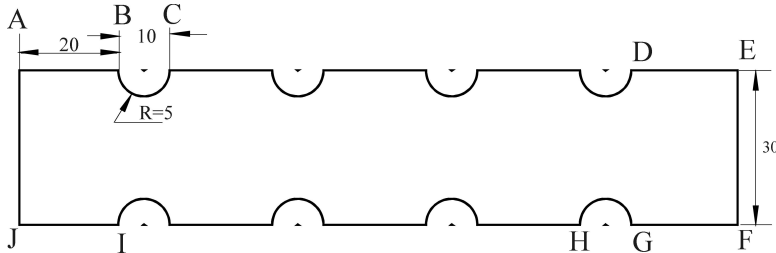
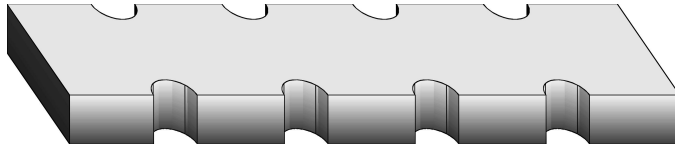

Program as follows:

```

N0000 G17 G90 X0 Y0 F250 M03 ;
N0001 G91 G01 Z-10
N0010 G22 L4 ;
N0020 G01 X20 ;
N0030 G03 X10 I5 J0 Y0 ;
N0040 G800 ;
N0050 G01 X20 ;D-E line
N0060 Y-30 ;E-F line
N0070 G11 X140 Y-30 ;set mirror
N0080 G22 L4 ;circulation begin
N0090 G01 X20 ;F-G line
N0100 G03 X10 I5 ;G-H arc
N0110 G800 ;circulation end
N0120 G01 X20 ;I-J line
N0130 G01 Y-30 ;cancel mirror
N0140 G12 ;J-A line
N0150 G26 ;go back to program begin point
N0160 M02 ;over
    
```

(19) Accurate localization/Continual way processing (G60/G64)

According to requirement of processing, we can set program section connection way by the G60/G64 instruction.

```

Format: G60 ; accurate stop (mode)
        G64 ; continue section (mode, original)
    
```

(20) Circle instruction (G73、G74、G80~G89)

Using Circle instruction, we can shorten the program length,make the program more simple.

Circle instruction table

G	Feed method	Motion in the	withdraw	application
---	-------------	---------------	----------	-------------

code		bottom of hole		
G73	Intermission feed	No	Rapid move	High speed drill deep hole
G80	Continue feed	No	No	Cancel fixed cycle
G81	Continue feed	No	Rapid move	Drill cycle
G82	Continue feed	Stop	Rapid move	Drill cycle
G83	Intermission feed	No	Rapid move	Drill deep hole cycle
G85	Continue feed	No	Cutting feed	Bore hole cycle
G86	Continue feed	Spindle stop	Rapid move	Bore hole cycle
G89	Continue feed	Spindle stop	Cutting feed	Bore hole cycle
G74	Continue feed	Stop-Spindle rotate CW	Cutting feed	Left tap cycle
G84	Continue feed	Stop-Spindle rotate CCW	Cutting feed	Right tap cycle

Cycle instruction is consist of six motions

- Motion 1 location of X and Y axis
- Motion 2 rapid move to R point
- Motion 3 machining hole
- Motion 4 action in the bottom of hole
- Motion 5 withdraw to R point
- Motion 6 rapid move to original point

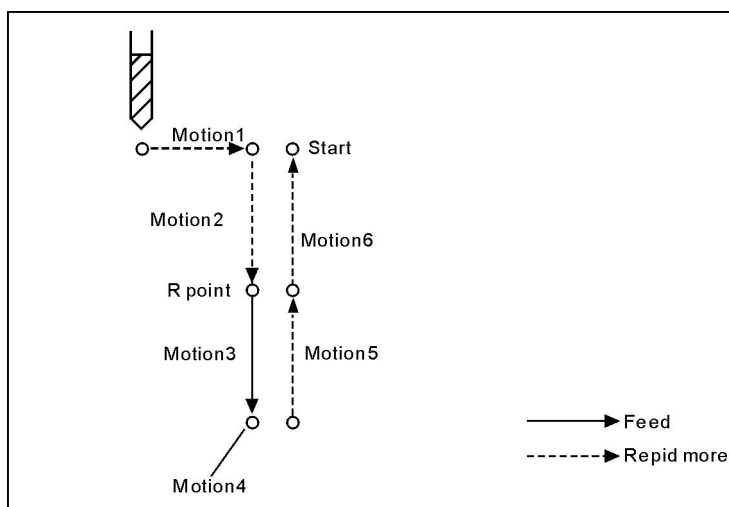

The difference of G90 and G91 as follow:

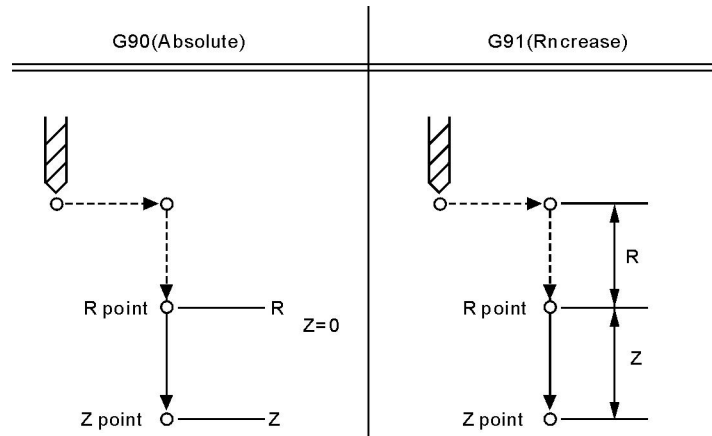

When tool touched the bottom of hole, tool will back to plane where R point stands, or original plane. Generally, G99 is used in first drilling, and G98 is used in final drilling. the original plane will not change even by G99, The difference of G98 and G99 as follow:

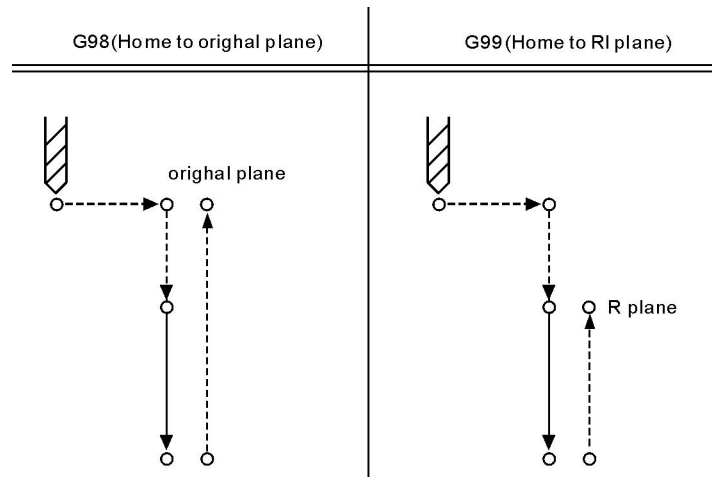

Use the L word to set cycle time, and L is just valid in specified segment. the maximum value is 9999, the default value is 1;

Orientation plane is determined by G17(XY)/G18(ZX)/G19(YZ). Besides, speed parameter P41 arc backlash compensation is set as 2 or 10.

(21) High speed drill deep hole(G73)

This cycle execute high speed drilling deep hole until reaching to bottom, at the same time, remove the cutting trifling from hole.

Format: G73 X_Y_Z_R_Q_F_L_ ;
 X_Y_:hole position data
 Z_:the distance(G91) or coordinate(G90) from R point to hole bottom
 R_: the distance(G91) or coordinate(G90) from original point to R point
 Q_:cutting depth every time
 F_:cutting speed
 L_:repeated times

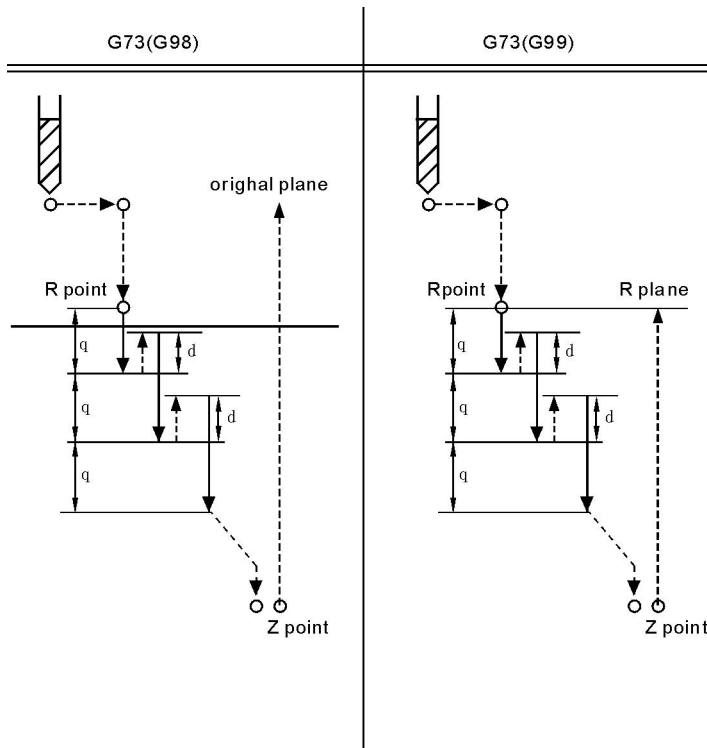

Note: High speed drilling cycle along the Z axis to carry out intermittent feeding, when using this cycle, the swarf can be easily discharged from the hole and can set the smaller value when backing. This allows to carry out drilling effectively. No.1 parameter in "N"(Processing) parameter is to set the value of the tool withdrawal(d).

Using auxiliary function to rotate spindle before specifying G73 (M code).

Set the offset of tool length(G43 G44 or G49) in changeless cycle which is located to R point to plus offset, the offset of tool radius is ignored.

For example:

```

M3 S2000                               Spindle starts rotating
G90 G99 G73 X300. Y-250. Z-150. R-100. Q15. F120. Drill the fist hole and
return to R point
Y-550.;                                 Drill the second hole and return to R point
G98 Y-750.;                               Drill the third hole and return to R point
G80
M30;                                     The end
    
```

(22) Drilling cycle, point drilling cycle(G81)

The cycle is used for normal drilling, execute the feeding cut to hole bottom. Then, the tool moves fast return form hole bottom.

Format: G81 X-Y-Z-R-F-L- ;
 X-Y-: Data of hole position
 Z-: Distance form R point to hole bottom (G91)
 or coordinate value (G90)
 R-: Distance form initial point to R point (G91) or
 coordinate value (G90)
 F-: Cutting speed
 L-: Repeated times

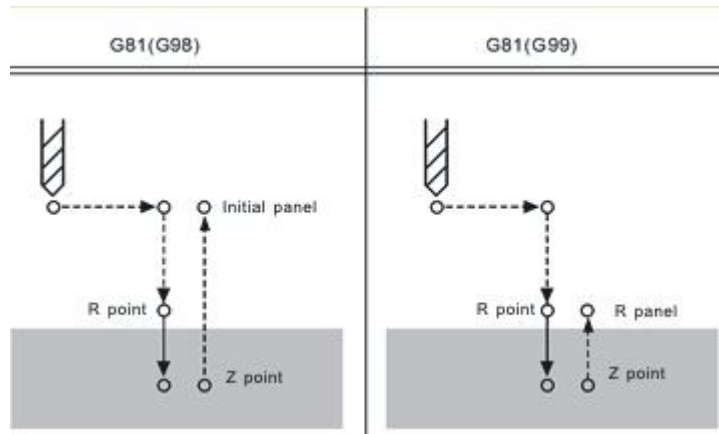

Note: Move fast to R point along the X and Y axis location, execute drilling process from R point to Z point, then tool returns with rapid move.

Use auxiliary function M code to rotate spindle before specifying G81

Locate to R point plus the offset when specifying the offset of tool length(G43 G44 or G49) in fixed cycle, the offset of tool radius is ignored.

Example:

M3 S2000; spindle begins to rotate

G90 G99 G81 X300 Y-250 Z-150 R-100 F120; drill the first hole, and then return to R point

Y-550; drill the second hole, and then return to R point

G98 Y-750; drill the third hole, and then return to panel of the initial position

G80

M30; end

(23) Drilling cycle,Reaming cycle(G82)

The cycle is used to drill hole,servo cut to the bottom and pause, then tool recede rapidly.

Format: G82 X-Y-Z-R- P -F-L- ;
 X-Y-: hole position data
 Z-: the distance(G91) or coordinate(G90) from R
 point to hole bottom
 R-: the distance(G91) or coordinate(G90) from
 original point to R point
 P-:pause time
 F-:cutting speed
 L-:repeat time

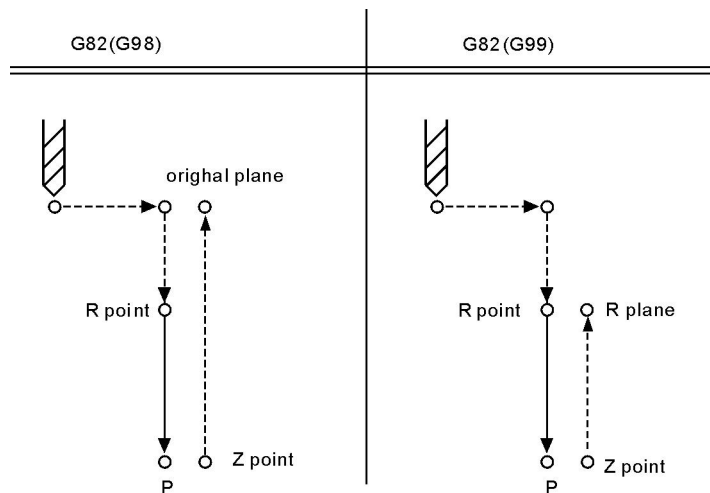

Note:orientating in the direction of X axis and Y axis, rapidly move to R, then drill from R to Z point, when tool arrive at the bottom, execute pause,then tool recede rapidly.

Rotate spindle with M code before G82 specified.

Set offset in the location of R point, while specify tool length offset(G43,G44,G49) in fixed cycle. Tool radius offset is ignored.

For example:

```
M3 S2000
G90 G99 G82 X300. Y-250. Z-150. R-100. P1000 F120.
Y-550.;
G98 Y-750.;
G80
M30;
```

(24) Intermission drill cycle (G83)

It applies to chip removal from hole during the execution of intermittent feeding cut to bottom of hole.

Format : G83 X_ Y_ Z_ R_ Q_ F_ L_ ;
 X_ Y_ : hole position data
 Z_ : the distance(G91) or coordinate(G90) from R point to hole bottom
 R_ : the distance(G91) or coordinate(G90) from original point to R point
 Q_ :cutting depth every time
 F_ :cutting speed
 L_ :repeated times

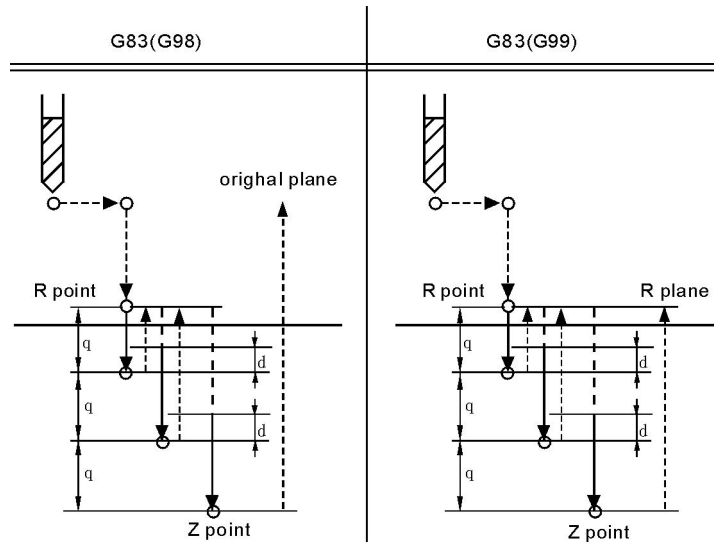

Note: Q means the cutting depth of each cutting feed, it must be specified in the incremental value. Cutting feed in the second and later must be executed quickly to move to d point to execute again before the end of last drilling, No.2 parameter in processing parameter set the cutting feed d, must specify the positive value in Q, negative is ignored.

Use the auxiliary functions M code to rotate spindle before specifying G83.

Set offset in the location of R point, while specify tool length offset(G43,G44,G49) in fixed cycle. Tool radius offset is ignored.

For example:

```

M3 S2000                                spindle starts;
G90 G99 G83 X300. Y-250. Z-150. R-100. Q15. F120. drill the first hole, back
                                           to R;
Y-550.;                                  drill the second hole, back to R;
Y-750.;                                  drill the third hole, back to R;
G98 Y-600.;                               drill the fourth hole, back to original plane;
G80
M30;                                       End.
    
```

(25) Boring cycle(G85)

Format: G85 X_ Y_ Z_ R_ F_ L_ ;
 X_ Y_ : Hole position data
 Z_ : the distance(G91) or coordinate(G90) from R point to hole bottom
 R_ : the distance(G91) or coordinate(G90) from original point to R point
 F_ :cutting speed
 L_ :repeated times

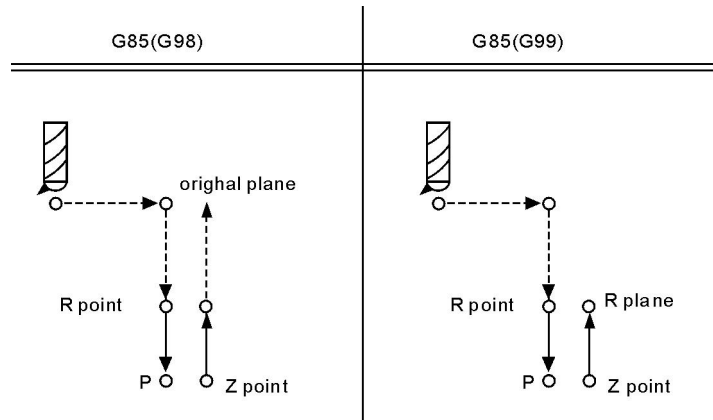

Note: Along the X and Y axis to locate, move fast to R point and carry out boring from R point to Z point, carry out cutting feed and return to R point when arriving the bottom of hole.

Set offset in the location of R point, while specify tool length offset(G43,G44,G49) in fixed cycle. Tool radius offset is ignored.

For example:

```

M3 S100                spindle starts
G90 G99 G85 X300. Y-250. Z-150. R-120. F120.bore the first hole, back to R;
Y-550;                bore the second hole, back to R;
Y-750;                bore the third hole, back to R;
G98 Y-600;            bore the fourth hole, back to original plane
G80
M30;                  End
    
```

(26) Boring cycle(G86)

Format: G86 X_ Y_ Z_ R_ F_ L_ ;
 X_ Y_ : hole position data
 Z_ : the distance(G91) or coordinate(G90) from R point to hole bottom
 R_ : the distance(G91) or coordinate(G90) from original point to R point
 F_ :cutting speed
 L_ :repeated times

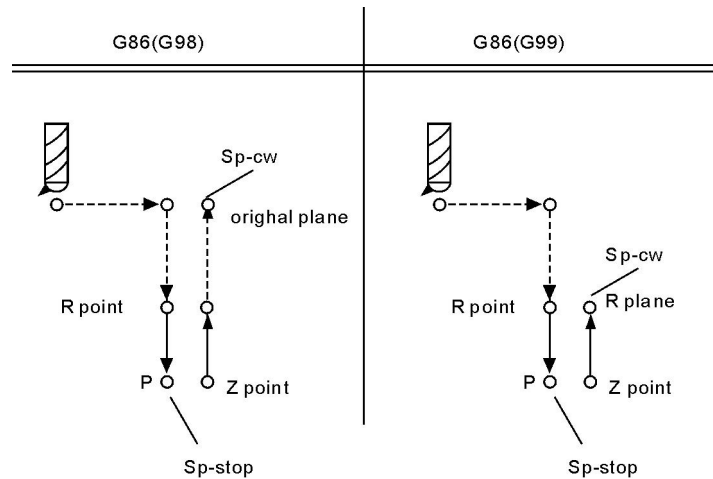

Note: Along the X and Y axis to locate, move fast to R point and carry out boring from R point to Z point. The tool will return quickly when spindle stopping at the bottom of hole.

Set offset in the location of R point, while specify tool length offset(G43,G44,G49) in fixed cycle. Tool radius offset is ignored.

For example:

M3 S2000	Spindle starts
G90 G99 G86 X300. Y-250. Z-150. R-100. F120.	bore the first hole, back to R;
Y-550.;	bore the second hole, back to R;
Y-750.;	bore the third hole, back to R;
G98 Y-600.;	bore the fourth hole, back to original plane
G80	
M30;	End.

(27) Boring cycle, Back boring cycle(G87)

G87 only works in machine center controller(NEW1000MiC/NEW18iMi), because it requires that spindle has orientation function(output M61, check M22). During finishing boring, when tool reaches bottom of hole, spindle stops, and tool will leave the surface of work piece according to direction defied by Processing parameter P4.

Format: G87 X_ Y_ Z_ R_ Q_ P_ F_ L_ ;

X_ Y_ : hole position data

Z_ : the distance(G91) or coordinate(G90) from R point to hole bottom

R_ : the distance(G91) or coordinate(G90) from original point to R point

Q_ : offset value in hole bottom, direction is defined by processing parameter P4;

P_ : pause time unit:s

F_ : cutting speed

L_ : repeat times

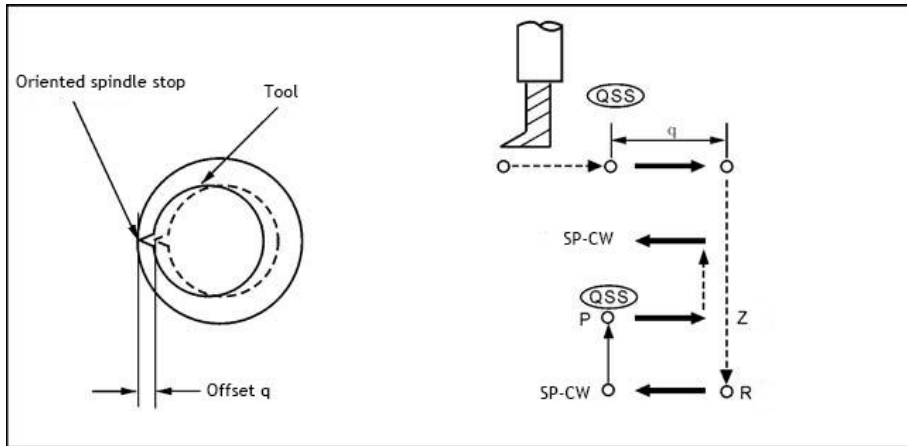

Note: after positioning in the X and Y axis direction, spindle stops at fixed degree. Tool moves rapidly in reversed direction(defined by process parameter P4,P5) of tool endpoint, then position at R point of hole bottom. Then tool moves in direction of tool endpoint and spindle rotate CW. Boring to Z point in the Z positive direction. Spindle stops at fixed degree when reaches Z point, tool moves rapidly in reversed direction(defined by process parameter P4,P5) of tool endpoint, afterwards tool retract to initial position, tool shifts in tool endpoint direction, spindle rotates CW, go to next segment.

please use M code to rotate spindle before G87. specifying tool length offset(G43,G44,G49) during fixed circle while positioning at R point, tool radius offset will be ignored.

Sample:

```

N10 M3 S100 ; spindle starts
N20 G90 G99 G87 X300 Y-250 Z-150 R-100 Q5 ; position, boring 1 hole,
then back to R point, orientation at hole bottom then move 5mm
N30 Y-350 ; boring 2 hole, then back to R point
N40 Y-550 ; boring 3 hole, then back to R point
N50 Y-750 ; boring 4 hole, then back to R point
N60 G80
N70 M30
    
```

(28) Boring cycle(G89)

Format: G89 X_ Y_ Z_ R_ P_ F_ L_ ; X_ Y_ : hole position data Z_ : the distance(G91) or coordinate(G90) from R point to hole bottom R_ : the distance(G91) or coordinate(G90) from original point to R point P_ :pause time F_ :cutting speed L_ :repeated times
--

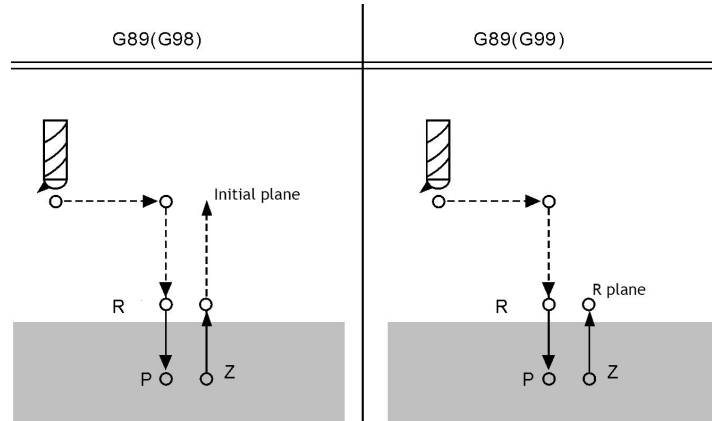

Note: It is the same as G85 unless suspending at the bottom of hole.
 Rotate spindle with M code before G82 specified.
 Set offset in the location of R point, while specify tool length offset(G43,G44,G49) in fixed cycle. Tool radius offset is ignored.

For example:

```

M3 S100                Spindle starts;
G90 G99 G89 X300. Y-250. Z-150. R-120. P1000 F120.bore the first hole, back
                        and pause for 1 second at the bottom;
Y-550.;                bore the second hole, back to R;
G98 Y-750.;            bore the third hole, back to original plane
G80
M30;                   End
    
```

(29) Finishing boring cycle(G76)

G74 only works in machine center controller(NEW1000MiC/NEW18iMi), because it requires that spindle has orientation function(output M61, check M22). During finishing boring, when tool reaches bottom of hole, spindle stops, and tool will leave the surface of work piece according to direction defied by Processing parameter P3.

Format: G76 X_ Y_ Z_ R_ Q_ P_ F_ L_ ;
 X_ Y_ : hole position data
 Z_ : the distance(G91) or coordinate(G90) from R point to hole bottom
 R_ : the distance(G91) or coordinate(G90) from original point to R point
 Q_ : offset value in hole bottom, direction is defined by processing parameter P3;
 P_ : pause time unit:s
 F_ : cutting speed
 L_ : repeat times

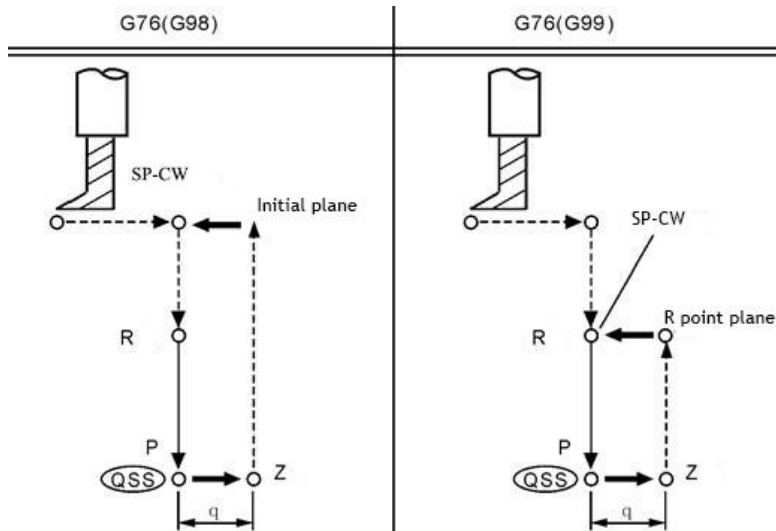

Note: when reaches hole bottom, spindle tops in fixed degree, and tool will return in revered direction of tool point, which will make sure process surface not be damaged. Spindle orientation degree is defined by process parameter P5. please use M code to rotate spindle before G76. specifying tool length offset(G43,G44,G49) during fixed circle while positioning at R point, tool radius offset will be ignored.

Sample:

```

N10 M3 S100 ;spindle start
N20 G90 G99 G76 X300 Y-250 Z-150 R-100 Q5 ; position, boring 1 hole, then
back to R point, orientation at hole bottom then move 5mm.
N30 Y-350 ; position, boring 2 hole, then back to R point,
N40 Y-550 ; position, boring 3 hole, then back to R point,
N50 Y-750 ; position, boring 4 hole, then back to R point,
N60 G80
N70 M30
    
```

(30) Left tap cycle(G74)

Tapping has two kinds of methods: Tracking the spindle encoder (P411=2, spindle must assemble encoder) and interpolation of Z axis and spindle servo (P405=0, P410=95, P411=3). No.404~No.413 parameter in axis parameter to set.

Pay attention:

When spindle and encoder do not drive as 1:1, please modify the No.412 No.413 parameter in axis parameter;

412, the number of spindle teeth (requirement: less than or equal to the number of encoder teeth, must match our keysets when greater than the number of encoder teeth);

413, the number of encoder teeth

The loop is executed with tapping left, in the left tapping cycle, the depth Q of feeding, CCW spindle back distance d(by process parameter P7), type of chip removal set by process parameter P6(0 means high-speed removal and back by d, 8 means normal removal and back to R). the spindle rotates CW when arriving at the bottom of hole.

Format: G74 X_ Y_ Z_ R_ P_ K_ S_ L_ ;
 X_ Y_ : hole position data
 Z_ : the distance(G91) or coordinate(G90) from
 R point to hole bottom
 R_ : the distance(G91) or coordinate(G90) from
 original point to R point
 P_ : pause time unit:s
 K_ : screw pitch
 S_ : spindle rotate speed
 L_ : repeated times

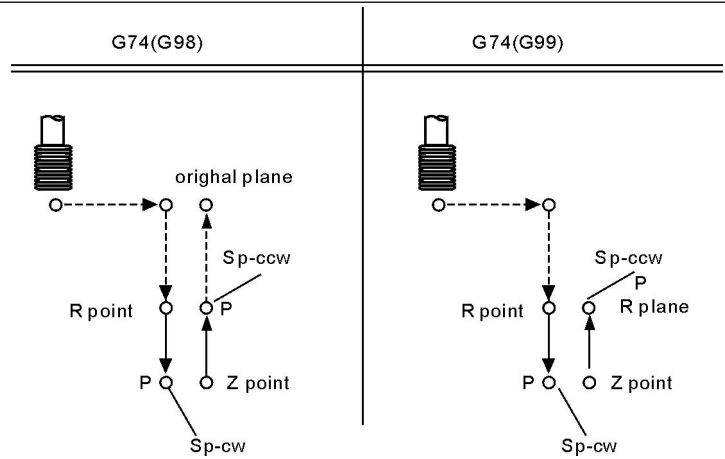

Note: The speed of coordinate axis is determined by speed of spindle and screw pitch when processing thread, it is not a matter with speed F. The system will limit the speed within maximum feeding speed.

Spindle override switch and feeding axis override switch are invalid when processing thread.

Should specify the screw pitch K value in every processing program segment of thread, otherwise not through compile.

Use spindle CCW rotation to carry out tapping. Should process a negative thread in order to return spindle CW rotation when arriving at the bottom of hole. In the left tapping period, feeding suspension does not stop lathe until the return action completed.

Use auxiliary function to rotate spindle CCW before specifying G74. When the spindle is pulse controlling mode without using auxiliary functions M code.

Set offset in the location of R point, while specify tool length offset(G43,G44,G49) in fixed cycle. Tool radius offset is ignored.

For example:

N1 M4 S100	Spindle starts;
N2 G90 G99 G74 X300. Y-250. Z-150. R-100. K5 S100	tap the first hole, then back to R point;
N3 G98 Y-550. K5;	tap the first hole, then back to R point;
N4 G80;	
N5 M30;	End;

(31) Right tap cycle(G84)

The same as G74 unless direction.

Format: G84 X_ Y_ Z_ R_ P_ K_ L_ ;
 X_ Y_ : hole position data
 Z_ : the distance(G91) or coordinate(G90) from R point to hole bottom
 R_ : the distance(G91) or coordinate(G90) from original point to R point
 P_ :pause time
 K_ :screw parameter
 S_ :spindle rotate speed
 L_ :repeated times

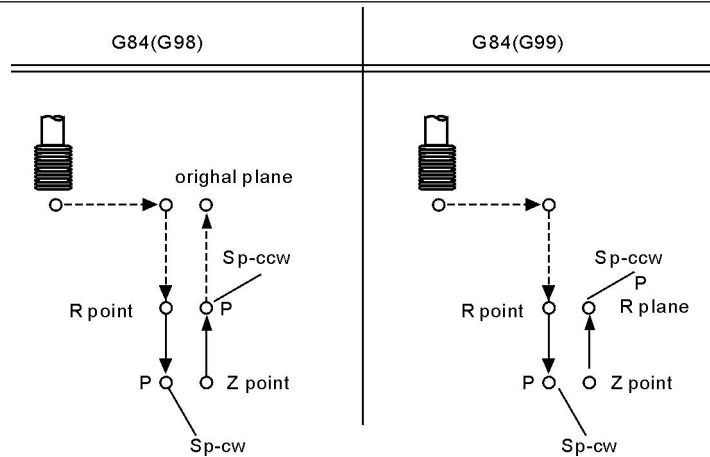

For example:

```
M3 S100           Spindle starts.
G90 G99 G84 X300 Y-250 Z-150 R-120 P300 K5 S100
                  Tap the first hole, then back to R;
Y-550. K5;       Tap the second hole, then back to R;
G98 Y-750. K5;   tap the third hole, then back to original plane;
G80
M30;             End.
```

(32) Cancel cycle instruction (G80)

Cancel cycle instruction.

Format: G80 ;

Note: Cancel all cycle instruction and execute normal operation.

(33) Pole coordinate instruction(G15/G16)

Pole coordinate instruction inquire user provide radius and angle,the positive direction of angle is anticlockwise of positive direction of the first axis in plane, and negative direction is clockwise. Radius may use absolute and increase type(G90, G91),Angle only use absolute type(G91).

Format :
G15 Cancel Pole coordinate;
(G17/G18/G19) (G90/G91) G16 IP_ ;establish

Note:

- 1.G17/G18/G19 specify the panel of pole coordinate instruction.
- 2.G90 specify the zero point of workpiece coordinate system as the origin of pole coordinate, measure radius from this point.
- 3.G91 specify current position as the origin of pole coordinate system, measure radius from this point.
- 4.IP_ specify the panel axis address and value of pole coordinate system panel selection.

First axis: Radius value of pole coordinate.

Second axis: Value of pole angle.

- 5.G90 set the zero point of workpiece coordinate system as origin of pole coordinate system:

Use programming instruction of absolute value to specify the radius(The distance between zero point and programming point).When using local coordinate system(G52), the origin of local coordinate system changes into the center of pole coordinate system, the angle uses absolute value. As the follow shown:

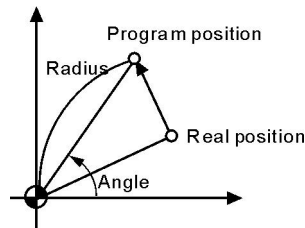

- 6.G91 set the current position as the origin of pole coordinate system:

Using programming instruction of incremental value to specify the radius(The distance between the current position and programming point).The angle use absolute value.As the follow shown:

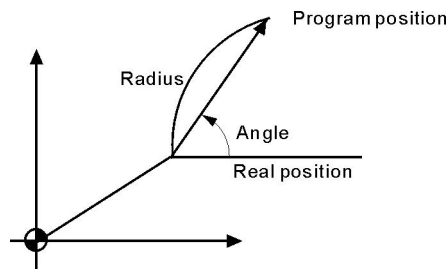

For example:

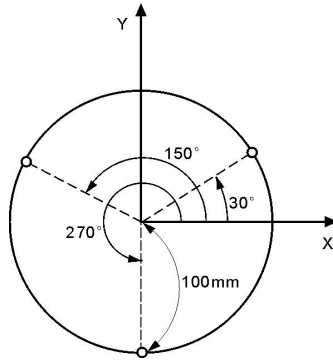

G17 G90 G16 X0 Y0; specify polar coordinate instruction, set the zero point of XY plane coordinate system as the original point of polar coordinate system;

G81 X100.0 Y30.0 Z-20.0 R-5.0 F200.0; specify distance of 100mm and angle of 30°;

Y150.0; specify distance of 100mm and angle of 150°

Y270.0; specify distance of 100mm and angle of 270°

G15 G80; cancel polar coordinate system.

(34) Metric system and British system(G20/G21), Feeding method(G94/G95)

Format:

G20 ; inch;

G21 ; millimeter;

G94: minute feeding;

G95: rotate feeding.

Note:The G code must be compiled in the beginning of the program, using separate program segment to specify before setting the coordinate system.Switch the unit of input data into minimal inch or millimeter after G code of switching inch or millimeter specifying,the angle of data input unit keeps unchanged, change the units of value as follows after switching the inch or millimeter:

- The feeding speed is specified by F code
- Position instruction
- Offset value of workpiece zero point
- Compensation value of tool
- The unit of manual pulse generator
- The distance in incremental feeding

Specification of unit under G20/G21(it is necessary to reset the unit in parameter):

- 1) The minimum unit of British system G20 is 0.0001inch, the minimum unit of Metric system is 0.001mm.
- 2) Under British system G20, unit of all instructions related to position is inch;
- 3) Under British system G20, unit of feeding speed F instruction is inch/min;
- 4) Under British system G20, unit of tool compensation and offset of workpiece

coordinate system G54-G59 is inch;

5) Under British system G20, unit of parameters related to distance(such as soft limit and compensation) change from mm of Metric system into 0.1 inch or from um into 0.001inch;

6) Under British system G20, unit of parameters related to speed change from mm/min into 0.1inch/min ;

7) Under British system G20, unit of parameters related to accelerated speed change from mm/min/s into 0.1inch/min/s;

8) Under British system G20, handwheel incremental value are 0.0001inch, 0.001inch, 0.01 inch;

9) Under British system G20,if pulse equivalent changes, system will adjust automatically, electronic gear will accords to metric system;

10) Under British system G20, coordinate displays four numbers behind the decimal point;

11) G20/G21 should be written in the beginning of program, instead of middle of program;

12) Under British system G20, rotary axis rotating 1 degree accords to 0.1 inch;

13) two systems can be converted by executing G20/G21 in MDI, and restating controller.

14) It is necessary to set tool after conversion between G20 and G21;

15) As to system prompt information, you just need to modify the parameter configuration file cncsystemen. For example, the parameter about speed: change mm/min into 0.1inch/min, parameter about position:change mm or degree into 0.1 inch, change um into 0.0001 inch.

(35) Back to start point of program(G26/G261-G264)

Format :	G26	; ZXY all go back.
	G261	; X go back.
	G262	; Y go back.
	G263	; Z go back.
	G264	; A go back.

Note: G26 motion is according to linkage type.

(36) Memory the current point(G25)

Format:	G25	; To remember the coordinate of X Y Z A
---------	-----	---

(37) Return to the memorial point(G61/G611-G618)

Format:	G61	;Return to X Y Z of memorial point
	G611	;Return to X of memorial point
	G612	;Return to Y of memorial point
	G613	;Return to Z of memorial point
	G614	;Return to A of memorial point

Note:the way that G61 back to the point memorized by G25 is by G00.

(38) Check skip(G31、 G311)

Format: G31 X_ Y_ Z_ A_ F_ P_ ;No alarm
G311 X_ Y_ Z_ A_ F_ P_ ;alarm

P: N line+(X00/X39+1000 or 2000), 1000 means skip when availability, 2000 means skip when invalidation.

For example: G31 X50 Z100 F100 P331022 ;if X22 availability then go to N33.
G311 X50 Z100 F100 P2021 ;if X21 invalidation then go to next line. And it will alarm till X21 is invalid.

(39) Automatic beveling (I) and smoothing(R)

The acquiescent panel of milling is G17

Format for G17:
G01(G00) X I automatic beveling, the coordinate in the next program segment must be G01(G00) Y.
G01(G00) Y I automatic beveling, the coordinate in the next program segment must be G01(G00) X。
G01(G00) X R automatic smoothing, the coordinate in the next program segment must be G01(G00) Y。
G01(G00) Y R automatic smoothing, the coordinate in the next program segment must be G01(G00) X。
Format for G18:
G01(G00) X I automatic beveling, the coordinate in the next program segment must be G01(G00) Z。
G01(G00) Z I automatic beveling, the coordinate in the next program segment must be G01(G00) X。
G01(G00) X R automatic smoothing, the coordinate in the next program segment must be G01(G00) Z。
G01(G00) Z R automatic smoothing, the coordinate in the next program segment must be G01(G00) X。
Format for G19:
G01(G00) Y I automatic beveling, the coordinate in the next program segment must be G01(G00) Z。
G01(G00) Z I automatic beveling, the coordinate in the next program segment must be G01(G00) Y。
G01(G00) Y R automatic smoothing, the coordinate in the next program segment must be G01(G00) Z。
G01(G00) Z R automatic smoothing, the coordinate in the next program segment must be G01(G00) Y。

Pay attention:

1.The address of I and R are specified with radius model. The running distance of this line and the next line must be greater than the length of beveling or radius of

smoothing, otherwise the system will decrease the length of beveling or radius of smoothing to minimal running distance of this line and the next line automatically.

2. The two adjacent lines must be 90 degrees.

For example:

```

0 G54 G0 X-50 Y-50 Z20
N1 M03 S500
N2 G01 G42 D01 X0 Y0 F200
N3 G01 Z-5
N4 X100 I4 ; Beveling4x4
N5 Y40 R6 ; SmoothingR6
N6 X47 R5 ; SmoothingR5
N7 Y70 I3 ; Beveling3x3
N8 X15

N9 X0 Y40
N10 Y0
N11 G0 X-50 Y-50 G40
N12 Z50
N13 M30

```

(40) Program call(M97 M98 M99)

Unconditional jump

The line running unconditional jump to the line which is specified by P; P4 stands for using four field of digital specify the program to the entrance line of the calling main program (mark line).

Subroutine call

In this system the subroutine should be an independent program.

M98 P L unconditional call subroutine instruction. P is to specify the name and path of subroutine call, L refers to the calling times address of subroutine.

The M98 instruction can be omitted without writing, format: PP file name, the file name can be hidden files, the first character of hidden files must be "HIDEFILE" at the beginning. Such as the file "HIDEFILE01", this program in the program area is not displayed, can use the instruction M98 PHIDEFILE01 or M98 P*01 or PP*01 or PPHIDEFILE01 when calling.

For example:

```
P sub/1390 means subroutine is tmp/NC/sub/1390
```

Note:

- 1.tmp/NC/ is the system's default path, sub is a folder for the following
- 2.The subroutine must be a independent program.
- 3.Method of the main program in USB calls the subroutine in USB: P[or P].

For example:

```

M98 P[A1234 means calling the subroutine A1234 in USB;
M98 P]SS12 means calling the subroutine SS12 in USB;
PP[FFDE means calling the subroutine FFDE in USB;
It needs to write the path of file if call the subroutine in folder of USB.

```



There must be space in front of L(Subroutine calling times). Return to the next program segment of main program when subroutine running to the end.If the program contains a fixed sequence or repeated pattern, then the sequence or pattern can be compiled to subroutine to save in memory storage in order to programme easily, the subroutine can be called by main program which is also can be called by another subroutine.

M99 is an instruction of ending subroutine return, must have this instruction to end the subroutine.

Pay attention:

- 1) M99 in the main program is the same as M02;
 - 2) M99 with P in the main program is the same as M97;
 - 3) M99 returns to main program call in subroutine is in the next line;
 - 4) M99 with P in the subroutine returns to P program line in main program;
- Subprogram can call another subprogram(embedded). no matter the program called is main program or subprogram, it will back to the program line next to main calling program. When the subprogram is called by the main program, it is consider as first-level subroutine.

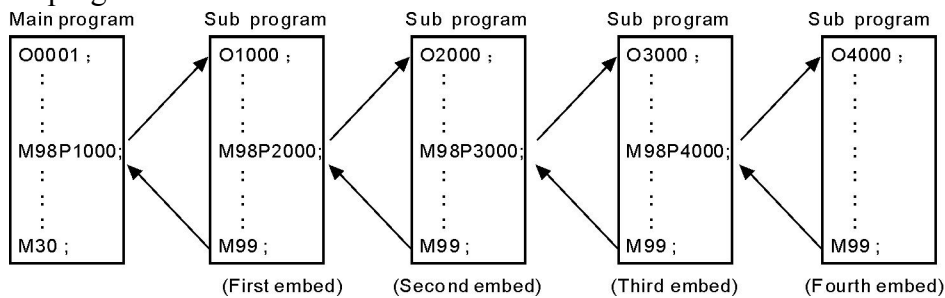
The Sub-program can embedded call as follow :



For example:

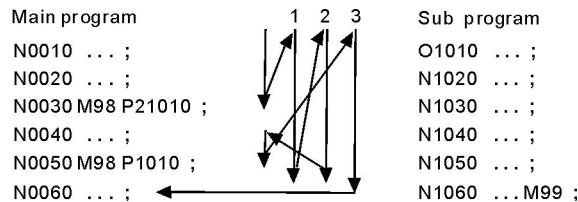

The calling instruction can be used for 9999 times in the most.

Conditional wait, jump instruction

The system of M code is used for detecting the external input signal as the condition, as follows:

Conditions wait

M12 M13 instruction are used to detect the input signal M12, M12 in program line is to detect M12 input signal is effective to execute the next program line , M13 means to detect M12 input signal is invalid to execute the next program line.The instruction is in an independent line.

M14 M15 instruction are used to detect the input signal M14, M14 in program line is to detect M14 input signal is effective to execute the next program line, M15 means to detect M14 input signal is invalid to execute the next program line.The instruction is in an independent line.

M16 M17 instruction are used to detect the input signal M16, M16 in program line is to detect M16 input signal is effective to execute the next program line, M17 means to detect M16 input signal is invalid to execute the next program line. The instruction is in an independent line.

M18 M19 instruction are used to detect the input signal M18, M18 in program line is to detect M18 input signal is effective to execute the next program line, M19 means to detect M18 input signal is invalid to execute the next program line. The instruction is in an independent line.

M22 M23 instruction are used to detect the input signal M22, M22 in program line is to detect M22 input signal is effective to execute the next line program, M23 means to detect M22 input signal is invalid to execute the next program line. The instruction is in an independent line.

M24 M25 instruction are used to detect the input signal M24, M24 in program line is to detect M24 input signal is effective to execute the next line program, M25 means to detect M24 input signal is invalid to execute the next program line. The instruction is in an independent line.

M28 M29 instruction are used to detect the input signal M28, M28 in program line is to detect M28 input signal is effective to execute the next line program, M29 means to detect M28 input signal is invalid to execute the next program line. The instruction is in an independent line.

Conditional jump

Plus Pxxxx (number of program line) in front of the M12 /M13 /M14 /M15 /M16 /M17 /M22 /M23 /M28 /M29 instruction. Shifting if the condition success, otherwise execute the next.

For example: M14 P0120

When the program running to this line and the system detecting the M14 input signal effectively, program will jump to the 120th line of program (the marking line), execute the next instruction if the M14 input signal is invalid.

M186/M187 welding follow instruction(optional for Bus type controller):

- (1) A axis is rotary axis, parameter set as all reduction, for tool rotation.
- (2) C axis is rotary axis, parameter set as all reduction, for tool rotation.

C axis positive direction and XYZ coordinate should be agreed with right hand coordinate principle.

(3) in order to perform C axis rotation degree between sections in program, the C axis command speed is G00 speed, and moves nearby.

(4) Command:

M186: open welding follow function

M187: close welding follow function

(5) sample:

G54 G0X10Y60Z30

M3S200

M186 ; open follow function

```
G1 Z50 F500 ; Z axis lift
G1X10Y63F200 ; XY axis tool endpoint align
G1 Z0 ; Z axis move to welding start point
X0Y-23
X10Y50
G2X-23.20Y130R90
M187 ;cancel follow function
M5
M30
```

(41) Feeding speed F function

It is the mode,actual running speed is the setting speed times the trimming rate of speed,

F is used for specify the processing speed of feeding instruction G01 G02 G03.

The range is 0.01-15000mm/min,feeding speed is Fx trimming speed, F has mode function.

Executing the F instruction at the first, and then execute the motion instruction when the F instruction and motion instruction are in the same line.

(42) T/H/D function

The T/H/D function is means that tool length and radius compensate,which is mode,used by code in program。

The tool code is from T01 to T99,every tool have four tool compensate value , which is length compensation from H1 to H99 and radius compensation from D1 to D99.

(43) Spindle speed S, SS

The system offers two ways spindle controlling modes.

The first spindle speed is specified by S, the first spindle has two kinds of gear controlling mode:

(1) The first is four gear spindle speed electrical control, output four bits code of step speed change, M41-M44 instruction control corresponds to S01-S04 output code, step speed change. Use Axis parameter P50, P51 ,P52, P53 and P54 to set the mode of shifting.

(2) The second uses four gears + step-less speed, M41-M44 instruction control, correspond the output S01-S04 code. Use speed parameter P42, P43, P44, P45 to set the maximum speed of corresponding gear, use Axis parameter P50, P51 ,P52, P53 and P54 to set the mode of shifting.

Stepless speed,the range is 0-99999, output 0-10V variable-frequency voltage. The output voltage trims x10V of maximum speed of specified spindle.

Second spindle speed is specified by SS, the highest speed is controlled by the speed parameter P46, output 0-10V variable-frequency voltage.

(44) Macro program instruction(G65,G66,G67)

1.Input instruction: WAT

Waiting for the input port X valid or invalid instruction

Format: WAT+ (-) X

Note: "+" to means the input is effective;

"-" means the input is invalid;

"X" means the input port X00-X55; see the I/O diagnosis;

2.The output instruction: OUT

Set the output port Y is valid or invalid instruction

Format: OUT +(-)Y

Note: "+" means the output is effective;

"-" means the output is invalid;

"Y" means the output port Y00-Y31; see the I/O diagnosis;

3. Variable and assignment: =

1) #0--#20 local variable: local variables only can be used to store data in macro program, such as a result of operation, when power is off, the local variables are initialized to the empty. The argument assignment to the local variable when calling the macro program.

2) #21--#600 global variables: The meanings are the same in different macro program.

When power is off, the variable #21--#100 is initialized to zero, the variable #101--#600 data is saved not to loss even if the power is off.

3) #1000-- system variable: the system variables are used to change various data when reading the running CNC. For example, the current position and the compensation of tool.

Special note: macro variables #100--#155 and #190--#202 have been used by the system, users can not use.

The global variable available for user are: #31-#99, #205-#379, #391-#999, the rest are occupied by system.

#161-#165 can used to display or record XYZAB coordinate in G31/G311.

#201: repeat times of G76(method 1).

#202: tool offset value in Z direction when G76 repeats. Uint:mm,(method 1).

#203: repeat times of G76(method 2).

#204: tool offset value in Z direction when G76 repeats. Uint:mm,(method 2).

4) The macro variables #1001--#1099 corresponds the X axis offset value of lathe T1--T99(Unit: micron)

The macro variables #1401--#1499 corresponds the Z axis offset value of lathe T1--T99(Unit: micron)

Could read the value, for example: #200=#1003; To read the X axis offset value of the third tool into macro variables #200.

Could modify the value, for example: #1003=23000; To modify the X axis offset value of the third tool to 23000 micron.

#1003=#1003+50; To increase the X axis offset value of the third tool 50 micron.

5)The I/O variables:

#1800: X00-X07 (D0-D7)

#1801: X08-X15 (D0-D7)

#1802: X16-X23 (D0-D7)

- #1802: X16-X23 (D0-D7)
- #1803: X24-X31 (D0-D7)
- #1804: X32-X39 (D0-D7)
- #1805: X40-X47 (D0-D7)
- #1806: X60-X67 (D0-D7)
- #1808: Y00-Y15 (D0-D15)
- #1809: Y16-Y31 (D0-D15)

Format:#i=Expression

6) Save all global macro variables with user program format.

FILEMS(AABBCC) or FILEMS[AABBCC]

To save #21-#999 into AABBCC files.

If you want to read these variables, just need to execute the file or call it as a subprogram.

4. The arithmetic and logic operation

Table:

Function	Format	Note
Definition	#i = #j	
Addition	#i = #j + #k ;	
Subtraction	#i = #j - #k ;	
Multiplication	#i = #j * #k ;	
Division	#i = #j / #k ;	
Sin	#i = SIN(#j) ;	90.5 degrees mean 90 degrees 30 minutes
Asin	#i = ASIN(#j);	
Cos	#i = COS(#j) ;	
Acos	#i = ACOS(#j);	
Tan	#i = TAN(#j);	
Atan	#i = ATAN(#j);	
Square root	#i = SQRT(#j);	
Absolute value	#i = ABS(#j) ;	
Rounding off	#i= ROUND(#j);	
Round down	#i = FIX(#j);	
Round up	#i = FUP(#j);	
Natural logarithm	#i = LN(#j);	
Exponential function	#i = EXP(#j);	
Or	#i = #j OR #k ;	Executing with binary system
Exclusive or	#i = #j XOR #k ;	
And	#i = #j AND #k ;	

5. Unconditional transfer: GOTO N

Transfer to the program line with sequence number appears error when specifying beyond the 1-99999, could use expression to specify the sequence number.

For example: GOTO 5, GOTO#100

6.Conditional transfer: IF (Conditional expression) GOTO or THEN

- 1) IF (Condition) GOTO or THEN
- 2) IF (condition)

```

<operation>
ELSE
<operation>
ENDIF
3) IF (condition)
<operation>
ELIF
<operation>
ELIF
<operation>
ENDIF

```

If the conditional expression specified meet, execute this segment; if the conditional expression specified does not meet, execute the next segment.

For example:

```

IF (#100 EQ 2) THEN #100=5
IF (#101 GT 2) GOTO 6

```

Operation meaning:

- EQ equal
- NE not equal
- GT greater than >
- GE greater than or equal >=
- LT less than <
- LE less than or equal

7. Cycle: WHILE (conditional expression) DO 1, 2, 3

Specifies a conditional expression in front of WHILE. When the specified conditions are met, execute the program between DO and END. Otherwise, turn to the program line after END. Cycle of the embed is 3 at the most.

For example:

```

WHILE (#100 LT 3) DO 1
.....
WHILE (#103 EQ 5) DO 2
.....
WHILE (#200 GE 20) DO 3
.....
END 3
.....
END 2
.....
END 1

```

8.Non-mode to call macro program:G65

Format: G65 P- L- <A-B-C-..... Argument passing data >

P is the name of macro program, L is the calling times,A B C are argument, the name of argument as follows:

#0->A、 #1->B、 #2->C、 #3->D、 #4->E、 #5->F、 #6->H、 #7->I、 #8->J、 #9->K、

#10->M、#11->Q、#12->R、#13->S、#14->T、#15->U、#16->V、#17->W、#18->X、
#19->Y、#20->Z.

Special attention: The address G、L、N、Q、P can't be used in argument.

For example:

```
Main program:9000
G00 X0 Z0
G65 P8000 L1 A5 B6
G0 X0 Z0
M30
Macro program:8000
N1 #2=#0+#1
N2 IF (#2 EQ 10) GOTO 4
N3 GOO X#2
N4 G00 Z#1
N5 M99 ; Return
```

9.Mode to call macro program:G66 G67

G67 instruction is to cancel G66 instruction.The format is the same as G65.

For example:

```
Main program:9000
G00 X0 Z0
G66 P8000 L2 A5 B6
A8 B1
A9 B10
G67
M30
Macro program:8000
N1 #2=#0+#1
N2 IF (#2 EQ 10) GOTO 4
N3 GOO X#2
N4 G00 Z#1
N5 M99 ; Return
```

10. information prompt dialog:

Format: MSG(parameter) or MSG[parameter]: parameter is information character string, pause;

Notice: the instruction also applies to NC program(non-macro program).

When prompting information dialog, system will convert into pause mode automatically.

Format: STAF(parameter) or STAF[parameter], parameter is information character string, not pause.

11. automatic generation of processing program

1> open the file:

FILEON(parameter) or FILEON[parameter]

Example: FILEON(AABBCC) or FILEON[AABBCC]

Means establish or open a file AABBCC.

2> Close the file

FILECE means close the current file, if not edit the instruction, the system will close the file automatically when the program is finished.

3> Write a string of character into opening file:

FILEWD (parameter) or FILEWD[parameter]

Example: FILEWD(G54G0X0Z0) or FILEWD[G54G0X0Z0]

Means write the string G54G0X0Z0 into the opening file.

4> Write the absolute coordinates of current feeding axis into the opening file.

Format: FILEWC

Example:

```
G0X0Z0
FILEON[AABBCC]
FILEWD [G54G0X0Z0]
G1X45Z89
FILEWC
G1X99Z76
FILEWC
FILECE
```

After the program finished, system will generated a file AABBCC under program directory. The contents is as following:

```
G54G0X0Z0
X45Z89
X99Z76
```

(45)User-defined macro instruction(G101-G170,M880-M889)

Every user-defined G code is corresponding to a macro program ProgramGxxx, the M code is corresponding to a macro program of ProgramUser0 --ProgramUser9, the user cannot programme the macro program in NC system, must edit the macro code in the computer, and then copy into the system.

For example, defines the G152 function: the arc model porous drilling cycle. (must copy the macro program ProgramG152 into system).

Format:G152 Xx Yy Zz Rr Ii Aa Bb Hh Ff;

X: The X coordinate with absolute value or incremental value of center to specify.

Y: The Y coordinate with absolute value or incremental value of center to specify.

Z: Hole depth

R: Approaching fast to the point coordinate

F: Cutting feed speed

I: Radius

A: The angle of the first hole

B: Incremental angle specify(CW when negative)

Macro program ProgramG152 as follows:

```
#80=#0
#81=#1
#82=#2
```



```
#83=#3
#84=#4
#85=#5
#86=#6
#87=#7
#88=#8
#89=#9
#90=#10
#91=#11
#92=#12
#93=#13
#94=#14
#95=#15
#96=#16
#97=#17
#98=#18
#99=#19
#100=#20
#30=#4003
#31=#4014
G90
IF[#30 EQ 90] GOTO 1
G53
#98=#5001+#98
#99=#5002+#99
N1 WHILE[#86 GT 0] DO 1
#35=#98+#87*COS[#80]
#36=#99+#87*SIN[#80]
G81X#35Y#36Z#100R#92F#85
#80=#80+#81
#86=#86-1
END 1
G#30 G#31 G80
M99
```

(46) Rough milling of groove in circle G110/G111:

Format: G99 G110/G111 X_Y_R_Z_I_W_Q_K_V_E_D_F_

Application: only the absolute type closed-loop controller support the function of G110-G142;

Function: starting from the center of circle, execute arc interpolation repeatedly in the way of spiral, till process the circle groove.

Definition of instruction: please refer to fixed cycle instruction in chart3-2.

G110: clockwise rough milling of circle groove;

G111: anticlockwise rough milling of circle groove.

1. I: radius of circle groove, I should be more radius of current tool;

2. W: the first cutting depth in the direction Z axis, the distance down from R reference plane, it should be more 0.(if the first cutting depth is more than groove bottom, processing can start from the bottom)

3. Q: increment of each cutting depth in the direction of Z axis.

4. K: increment of width cutting on the XY plane, it should be less than tool diameter, and more than 0;

5. V: the distance from the end processing plane when declining tool, it should be more than 0;

6. E: processing margin of rough milling of circle groove.(more than or equal to 0, negative value is absolute)

7.D: number of tool radius, range is 0-32, D0 default as 0, calling the current tool radius according to number.

Cycle process:

- (1) Rapidly locating at the XY plane;
- (2) Rapidly dropping to R point plane;
- (3) Cutting by depth W by the cutting speed;
- (4) Milling the disc of radius I and spread incrementally by K value from the center.
- (5) Z axis returns to R reference plane rapidly;
- (6) X and Y axis locate at the center;
- (7) Z axis drops rapidly by the distance V to end processing plane;
- (8) Z axis cuts by the depth Q+V;
- (9) Loop step 4-step 8 till processing of disc is finished.
- (10) Return to R point.
- (11) Return to X Y hole orientation position. Instruction tracking as following.

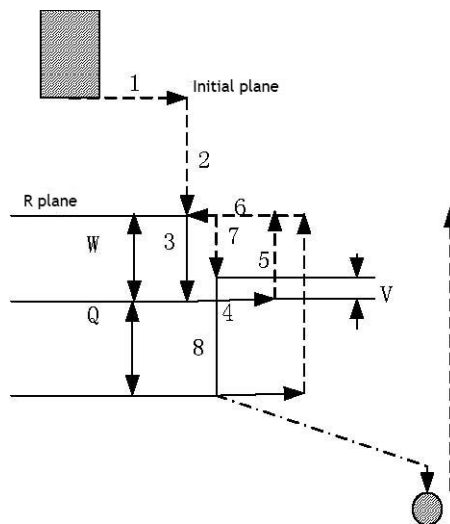

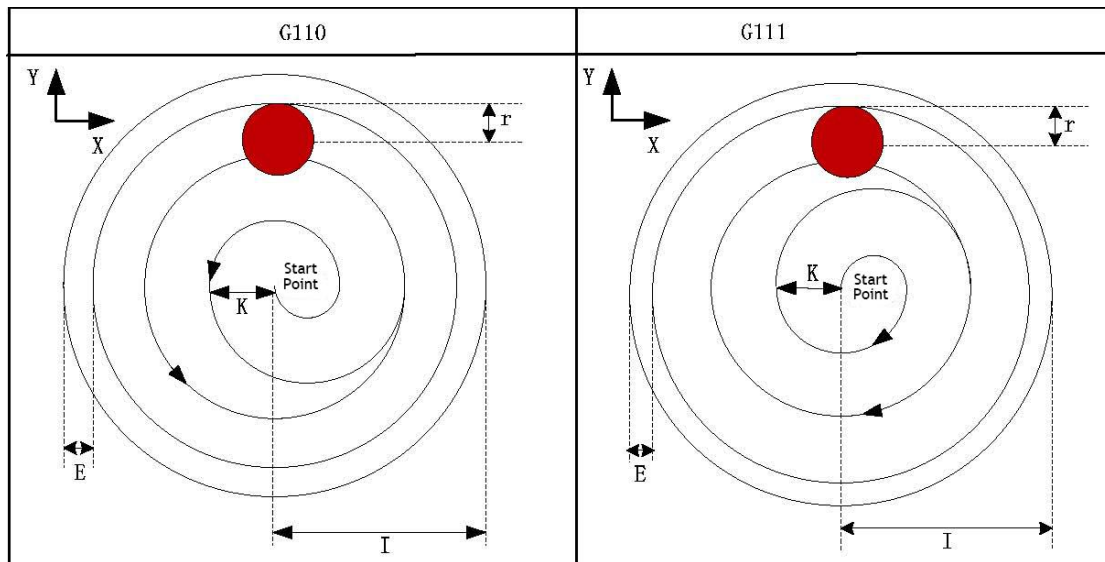

Example: rough milling of circle groove by fixed cycle G110, as following:

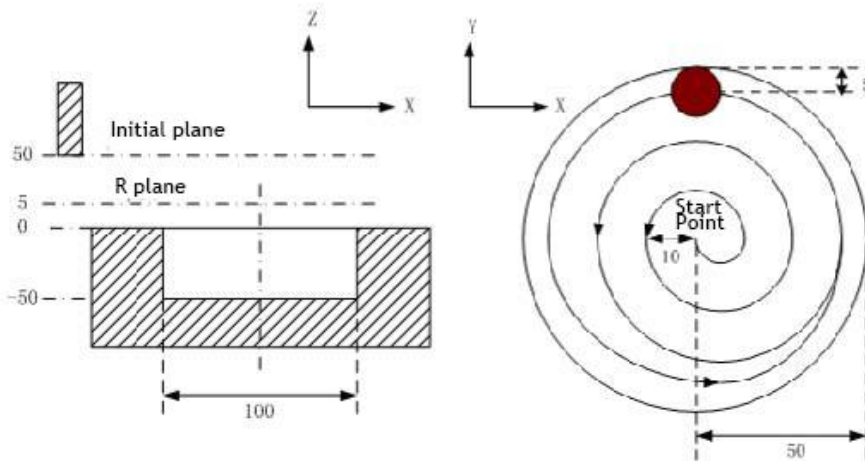

```
G90 G00 X50 Y50 Z50; (G00 rapid locating)
G99 G110 X25 Y25 R5 Z-50 I50 W20 Q10 K10 E0 V10 F800 D1 ; (rough milling of circle groove D1=5)
G80 X50 Y50 Z50; (cancel fixed cycle, return from R plane)
M30;
```

(47) Finishing milling cycle of inner circle G112/G113

Format: G99 G112/G113 X_ Y_ R_ Z_ I_ J_ D_ F_

Function: The tool mill inside a whole circle with the direction and radius I which is specified, return after the accurate milling.

Note: The relative instruction according to the table 3-2.

G112: finishing milling cycle CCW.

G113: finishing milling CW.

I: Circle radius of accurate milling, the range -99999999~99999999 times the minimum unit, take absolute value if negative.

J: The distance between the starting point of accurate milling and the center of accurate milling circle, the range $J \leq I - \text{the radius value of tool}$, take absolute value if

negative.

D: The number of tool, the range 1~32, D0 default is 0. Take out the radius of the current tool according to the number.

Cycle process:

- (1) Orient to the position of XY plane
- (2) Move down to the R point plane
- (3) Cutting feed to the hole bottom
- (4) Process the arc interpolation according to the track of transition arc 1
- (5) Whole circle interpolation according to the arc 2, arc 3
- (6) Arc interpolation to the starting point according to the track of transition arc 4
- (7) Fixed to return R point

The track:

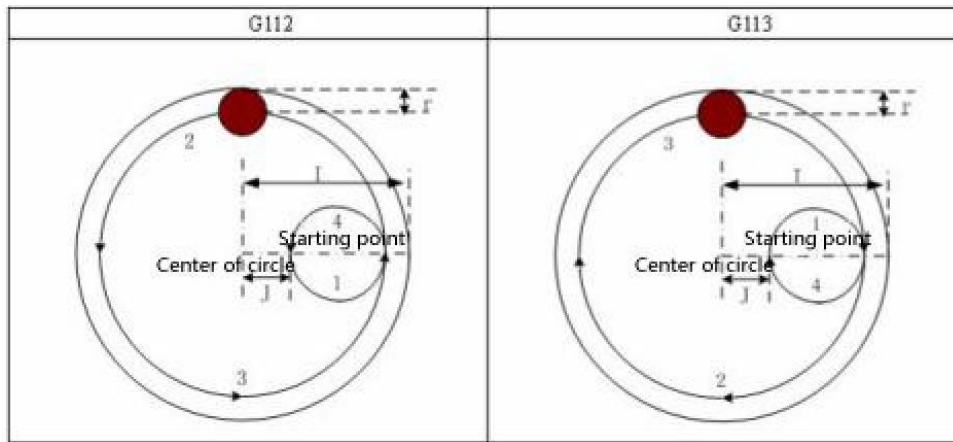

Note:

Q P L invalid under this cycle, but it will keep the value of Q P as the fixed mode cycle value to save.

Example: Use G112 to accurate milling the circle groove which has rough milled.

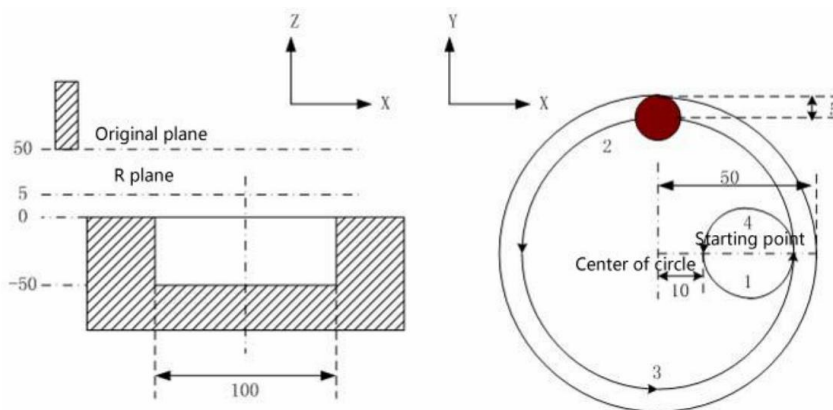

G90 G00 X50 Y50 Z50; (G00 orient with rapid move)

G99 G112 X25 Y25 R5 Z-50 I50 J10 F800 D1; (Start fixed cycle, move to the hole bottom and process accurate milling cycle in circle D1=5)

G80 X50 Y50 Z50; (Cancel the fixed cycle, return from R point plane)

M30;

(48) Finishing milling cycle of outer circle G114/G115

Format: G99 G114/G115 X_ Y_ R_ Z_ I_ J_ D_ F_

Function: The tool accurate milling a whole circle at excircle with the specified radius and direction, return after finishing.

Note: The relative instruction refers to the table 3-2.

G114: finishing milling cycle excircle CCW.

G115: finishing milling cycle excircle CW.

I: Circle radius of accurate milling, the range -99999999~99999999 times the minimum unit, take absolute value if negative.

J: The distance between the starting point of accurate milling and the center of accurate milling circle, the range $J \geq D$ (radius of tool), take absolute value if negative.

D: The number of tool, the range 1~32, D0 default is 0. Take out the radius of the current tool according to the number.

Cycle process:

- (1) Orient to the position of XY plane
- (2) Move down to the R point plane
- (3) Cutting feed to the hole bottom
- (4) Process the arc interpolation according to the track of transition arc 1
- (5) Whole circle interpolation according to the arc 2, arc 3
- (6) Arc interpolation to the starting point according to the track of transition arc 4
- (7) Fixed to return R point

The track:

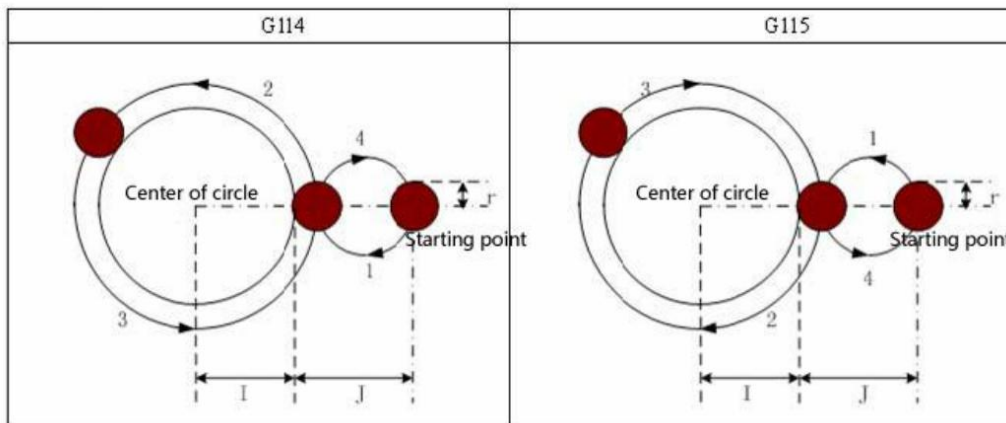

Note:

(1) The direction of transition arc and finishing milling arc is different when finishing milling excircle, the interpolation direction means the interpolation direction of accurate milling arc.

(2) Q P L invalid under this cycle, but it will keep the value of Q P as the fixed mode cycle value to save.

Example:

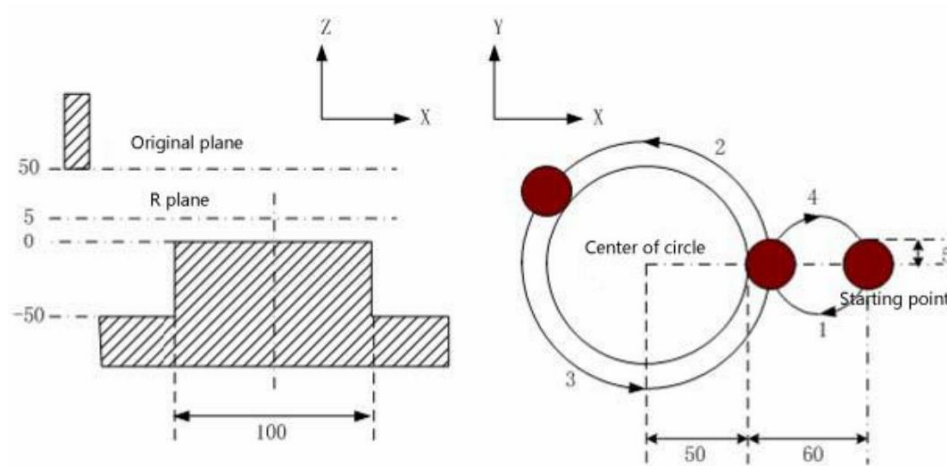

G90 G00 X50 Y50 Z50; (G00 orient)

G99 G114 X25 Y25 R5 Z-50 I50 J60 F800 D1; (Starts fixed cycle, move down to the hole bottom and process accurate milling cycle of excircle D1=5)

G80 X50 Y50 Z50; (Cancel the fixed cycle and return from R point plane)

M30;

(49) Rough milling cycle of excircle G116/G117

Format: G99 G116/G117 X_ Y_ Z_ R_ I_ J_ W_ Q_ K_ C_ E_ D_ F_

Function: Start from starting point, the tool process whole circle interpolation until process the size which is programmed.

Note: The relative instruction refers to the table 3-2.

G116: Rough milling cycle of excircle CCW

G117: Rough milling cycle of excircle CW

I: The radius of rough milling circle (should be greater than 0, take absolute value if negative)

J: The radius of workpiece (should be greater than 0, take absolute value if negative);

E: The allowance of rough milling excircle in XY plane (should be greater than 0 or equal to 0, take absolute value if negative);

W: The first time cutting depth with the direction of Z axis, the distance from the R plane move down, should be greater than 0, take absolute value if negative(if the first time cutting is deeper than the groove bottom, so process from the groove bottom)

Q: Every incremental depth with direction of Z axis, take absolute value if negative

K: The cutting incremental width in XY plane(should be smaller than the tool radius, greater than 0, take absolute value, if not to specify K, the default is the tool radius D)

C: The first time feed cutting (C should be greater or equal to the tool radius +2.0, X axis move positive direction when greater than 0, the workpiece is located at the positive direction. When smaller than 0, X axis move negative direction, the workpiece is located at the negative direction)

D: The number of tool, the range 0~32, D0 the default is 0. Take out the current tool radius according to the number which is specified

Cycle process:

- (1) Orient to the position of XY plane
- (2) Move down to the R point plane
- (3) Move down to W depth
- (4) Process straight interpolation to feed tool with the first time feeding value C of X axis and track of straight 1.
- (5) Process whole circle interpolation with track of arc 2
- (6) Every time according to the K value to increase to mill the (I+E) radius circle from outside to the center
- (7) Orient Z axis back to R plane
- (8) Orient to starting position(XY plane)
- (9) Z axis rapid move to the position (unmachined plane + Q)
- (10) Cycle 5~9 motion until finish all the cutting depth Z
- (11) Fixed return to R point
- (12) Return to starting position of XY

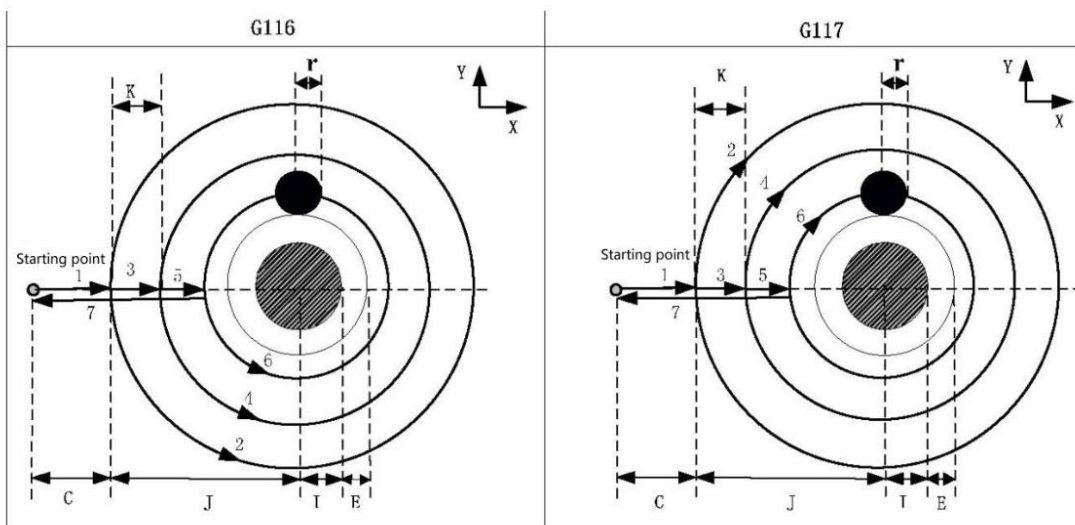
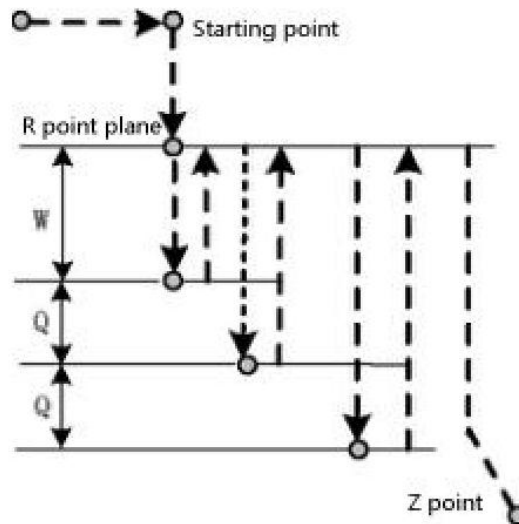

Note: P and L are invalid under the cycle, but it will keep the value of P as the fixed mode

cycle value to save.

Example: Use G117 to rough mill

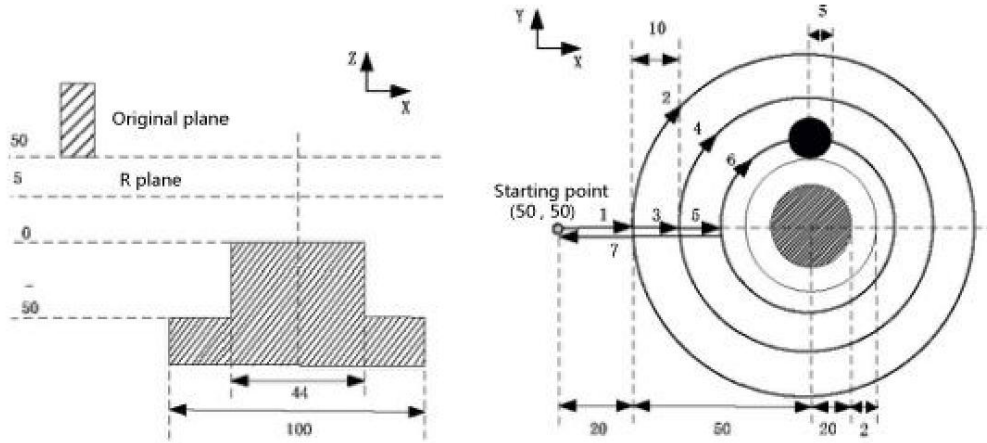

G90 G00 X0 Y0 Z50; (G00 orient)

G99 G117 X50 Y50 R5 Z-50 I20 J50 W20 Q10 K10 C20 E2 F800 D1; (process rough milling excircle cycle D1=5)

G80 X50 Y50 Z50; (cancel the fixed cycle, return from R point plane)

M30;

(50) Rough milling cycle of outer rectangle G132/G133

Format:G99 G132/G133 X_ Y_ Z_ R_ I_ J_ A_ B_ W_ Q_ K_ C_ E_ D_ F_

Function: Start from starting point to cycle the straight cutting according to the parameter until process the size which is programmed.

Note: The relative instruction refers to the table 3-2.

G132: Rough milling outer rectangle CCW

G133: Rough milling outer rectangle CW

XY: The coordinate position of processing point

I: The width of rough milling outside rectangle in direction of X axis (should be greater than 0. Take absolute value if negative)

J: The width of rough milling outside rectangle in direction of Y axis (should be greater than 0. Take absolute value if negative)

A: The width of blank in direction of X axis (should be greater than 0. Take absolute value if negative)

B: The width of blank in direction of Y axis (should be greater than 0. Take absolute value if negative)

E: The allowance of rough milling outside rectangle in XY plane (should be greater than or equal to 0. Take absolute value if negative)

W: The first time depth in direction of Z axis which is from R plane to downward position, should be greater than 0, take absolute value if negative (if the first time cutting is deeper than the groove bottom, so process from the groove bottom)

Q: Every time the incremental cutting depth in direction of Z axis, take absolute value if negative

K: The incremental cutting width in XY plane (should smaller than the tool radius, greater than 0, take absolute value if negative, if not specify K, the default is $K=D$ tool radius)

C: The first time feed cutting in direction of X (C should be greater or equal to the tool radius +2.0, X axis move positive direction when greater than 0, the workpiece is located at the positive direction. When smaller than 0, X axis move negative direction, the workpiece is located at the negative direction)

D: The number of tool, the range 0~32, D0 the default is 0. Take out the current tool radius according to the number which is specified

Cycle process:

- (1) Orient to the position of XY plane
- (2) Move down to the R point plane
- (3) Move down to W depth
- (4) Process straight interpolation to feed tool with the first time feeding value C of X axis and track of straight 1.
- (5) Process straight interpolation with track 2.
- (6) Every time according to the K value to increase to mill the rectangle with $(I+2E)$ long , $(J+2E)$ width.
- (7) Arc angle of milling rectangle
- (8) Z axis returns to R point plane
- (9) X and Y axis orient to the starting point plane
- (10) Z axis rapid move to the position (end processing plane + Q)
- (11) Cycle 4~9 motion until finish all the cutting depth Z
- (12) Fixed return to R point
- (13) Return to starting position of XY

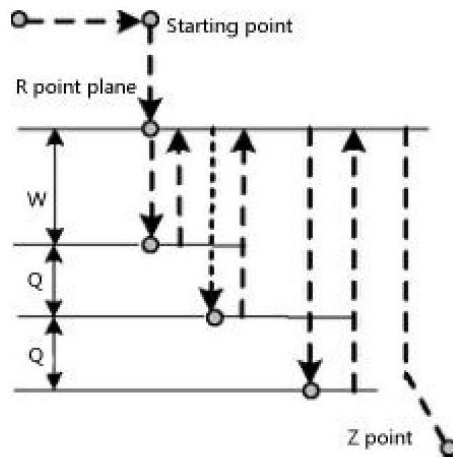

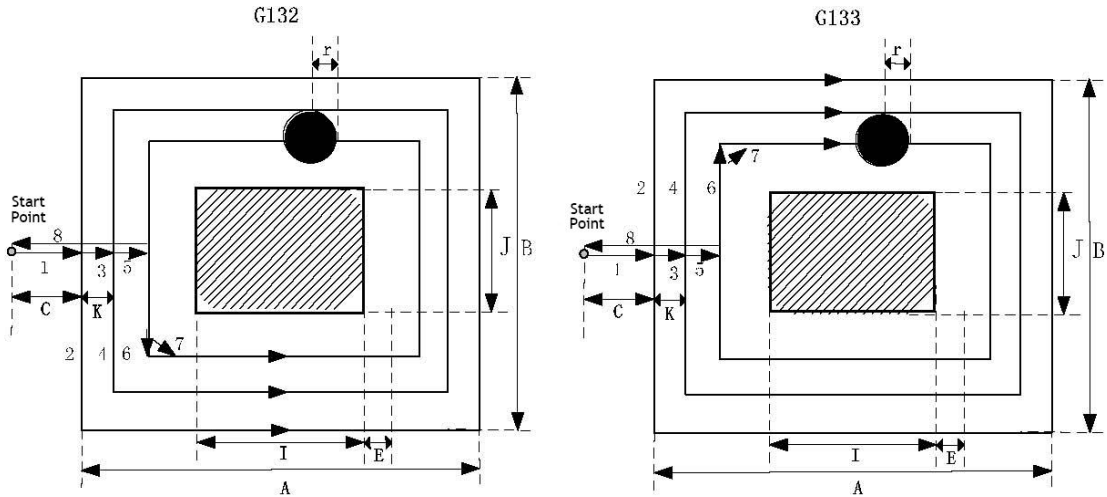

Note: P L invalid under the cycle, but it will keep the value of P as the fixed mode cycle value to save.

Example: Use G133 to rough mill

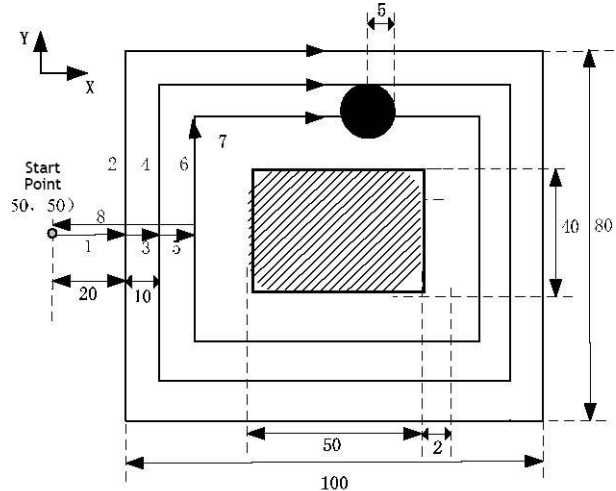
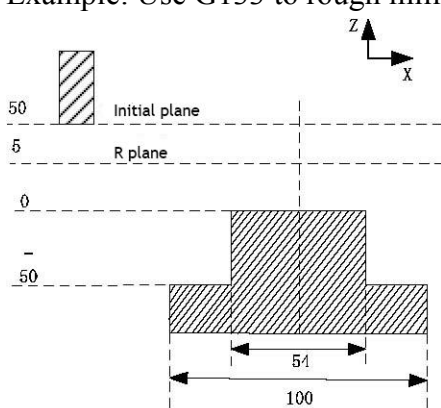

G90 G00 X0 Y0 Z50; (G00 to orient)

G99 G133 X50 Y50 R5 Z-50 I50 J40 A100 B80 W20 Q10 K10 C20 E2 U5 F800

D1; (Process the rough milling groove cycle D1=5 in rectangle)

G80 X50 Y50 Z50;

M30;

(51) Rough milling cycle of rectangle groove G134/G135

Format: G99 G134/G135 X_Y_Z_R_I_J_K_W_Q_E_V_D_F_

Function: Start from the center of rectangle to straight cutting cycle with the

specified parameter data until process the rectangle groove which is programmed.

Note: The relative instruction refers to the table 3-2.

G134: Rough milling the rectangle groove CCW.

G135: rough milling the rectangle groove CW.

I: The width of rectangle groove in direction of X axis.

J: The width of rectangle groove in direction of Y axis.

K: The cutting incremental width in X Y plane, should be less than the diameter of

tool, greater than 0.

W: The first time depth in direction of Z axis which is from R plane to downward position, should be greater than 0, take absolute value if negative (if the first time cutting is deeper than the groove bottom, so process from the groove bottom)

Q: Every time the incremental cutting depth in direction of Z axis, take absolute value if negative

V: The distance from the tool to the processing plane when tool starts moving, should be greater than 0

E: The allowance of rough milling rectangle groove in XY plane (should be greater than or equal to 0. Take absolute value if negative, take the parameter data when not to be specified)

D: The number of tool, the range 0~32, D0 the default is 0. Take out the current tool radius according to the number which is specified

Cycle process:

- (1) Orient to the position of XY plane
- (2) Move down to the R point plane
- (3) Move down to W depth
- (4) milling rectangle plane incrementally by K value from the center.
- (5) Z axis returns to R reference plane.
- (6) X and Y axis orient to the center of rectangle;
- (7) Z axis rapid move to the position (end processing plane + V)
- (8) Z axis cuts down by the distance(Q+V)
- (9) Cycle 4~8 motion until finish all the cutting depth;
- (10) Fixed return to R point
- (11) Return to starting position of XY
- (12) instruction tracking:

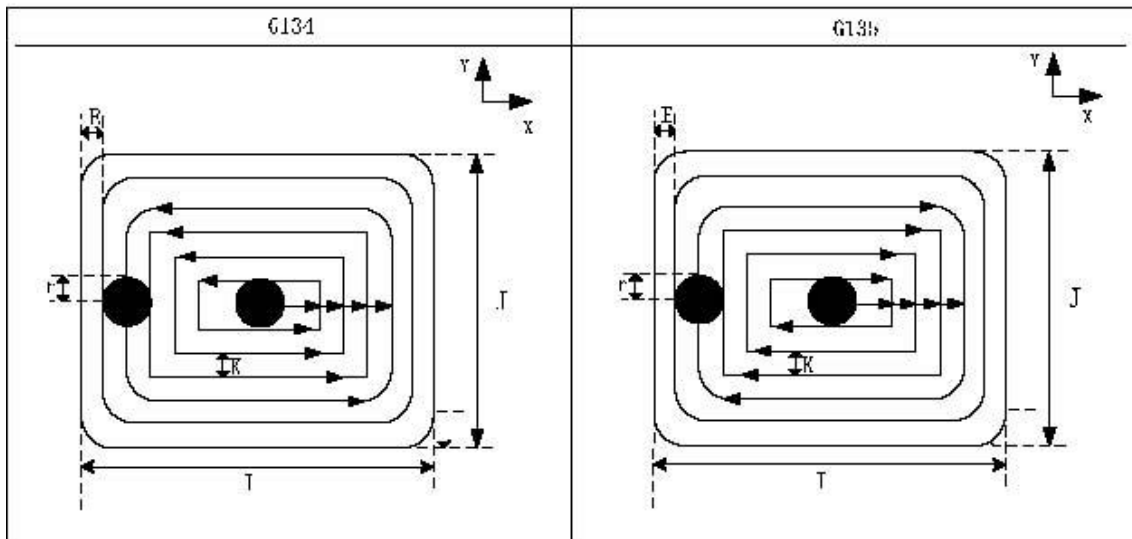
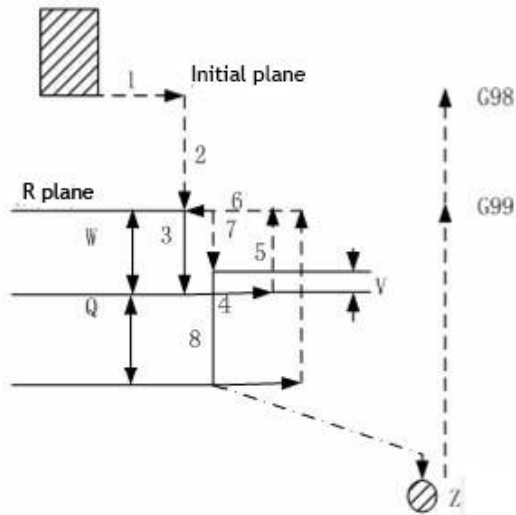

Note: P and L is invalid under the cycle, but it will keep the value of P as the fixed mode cycle value to save.

Example: Use the fixed cycle G134 to rough milling groove in rectangle

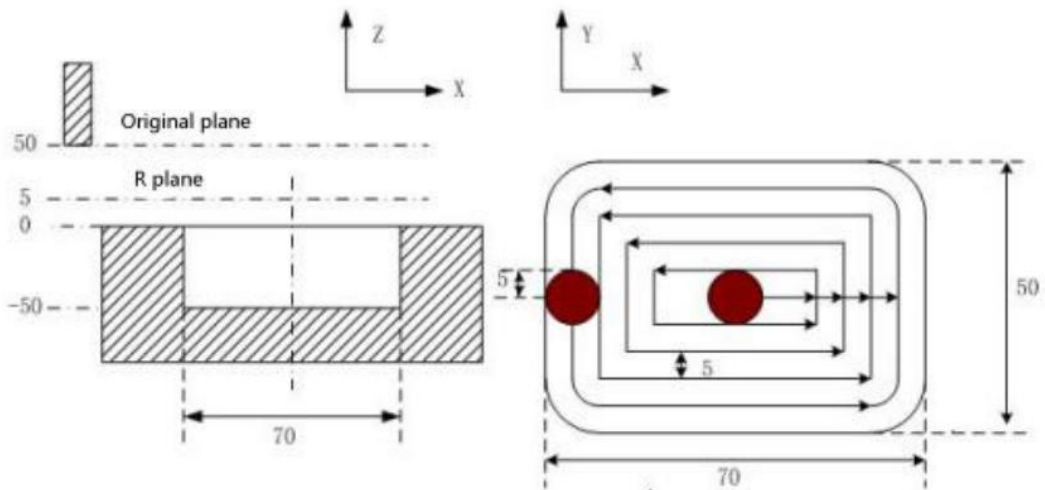

G90 G00 X50 Y50 Z50; (G00 to orient)
 G99 G134 X25 Y25 R5 Z-50 I70 J50 W20 Q10 K5 E0 V10 U10 F800 D1;
 (Process the rough milling groove rectangle cycle D1=5);
 G80 X50 Y50 Z5; (Cancel the fixed cycle, return from R point plane)
 M30;

(52) Finishing milling cycle of inner rectangle groove G136/G137

Format:G99 G136/G137 X_Y_R_Z_I_J_D_K_U_F_;

Function: The finishing milling in rectangle with specified width and direction, return after finishing.

Note: The relative instruction refers to the table 3-2.

G136: Finishing milling cycle in rectangle groove CCW.

G137: Finishing milling cycle in rectangle groove CW.

I: The width of rectangle in direction of X axis, the range: -99999999~99999999 times the minimum unit. Take absolute value when negative.

J: The width of rectangle in direction of Y axis, the range: -99999999~99999999 times the minimum unit. Take absolute value when negative. The value must greater than or equal to the tool radius D, otherwise it will alarm.

D: The number of tool, the range 0~32, D0 the default is 0. Take out the current tool radius according to the number which is specified

K: The distance from the starting point to the rectangle in direction of X axis, the range -99999999~99999999 times the minimum unit. Take absolute value when negative.

U: Corner radius of arc, omit means no corner arc to transition. When omitting U or U=0 and the tool radius greater than 0, it will alarm.

Cycle process:

- (1) Orient to the position of X Y plane;
- (2) Move to the R point plane;
- (3) Cutting feed to the hole bottom;
- (4) Start from starting point to arc interpolation with transition arc 1;
- (5) Process straight line and arc interpolation with 2-3;
- (6) Process arc interpolation to back to starting point with transition arc 4;
- (7) Fixed back to R point

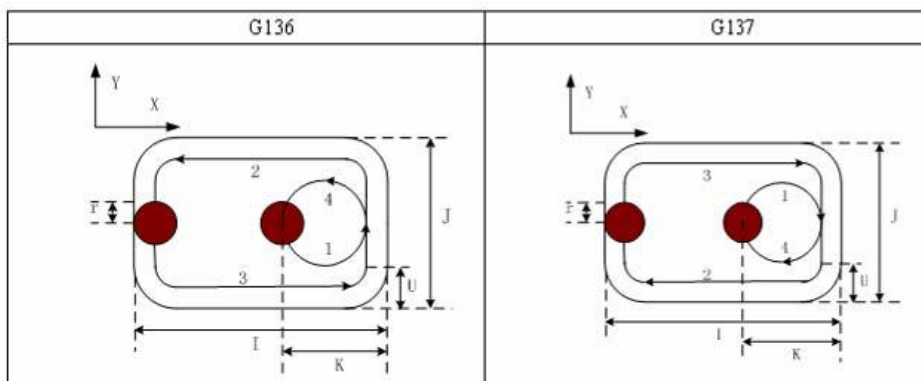

Note: P and L is invalid under the cycle, but it will keep the value of P as the fixed mode cycle value to save.

Example: Use the fixed cycle G136 to do finishing milling.

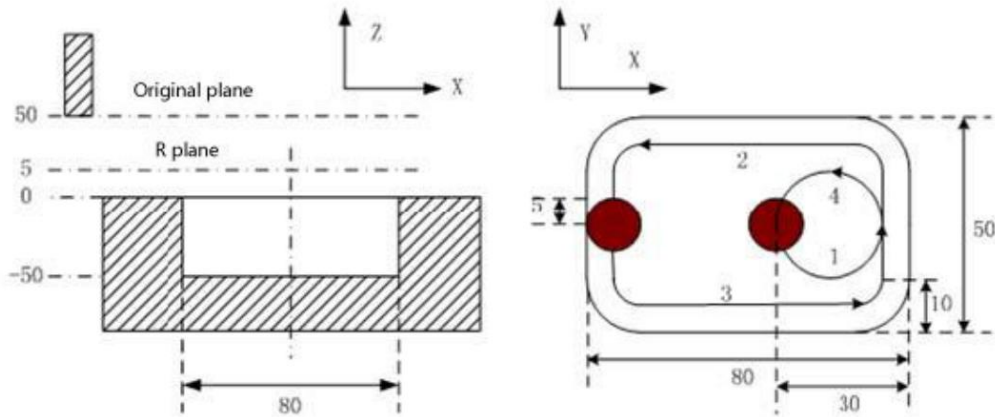

```
G90 G00 X50 Y50 Z50; (G00 rapid orientation)
G136 X25 Y25 R5 Z-50 I80 J50 K30 U10 F800 D1; ( Process accurate milling
D1=5 at the bottom of hole under the fixed cycle)
G80 X50 Y50 Z50; (Cancel the fixed cycle and return from R point plane)
M30;
```

(53) Finishing milling cycle of outer rectangle groove G138/G139/G141/G142

Format: G99 G138/G139/G141/G142 X_ Y_ R_ Z_ I_ J_ D_ K_ U_ F_

Function: The tool finishing milling on the outer the rectangle with specified width and direction, return after finishing.

Note: The relative instruction refers to the table 3-2.

G138: Finishing milling outside the rectangle CCW.

G139: Finishing milling outside the rectangle CW.

G141: Finishing milling of outer lateral rectangle or square (I>J).

G142: Finishing milling of outer vertical rectangle or square (I<J).

I: The rectangle width in direction of X axis, the range -99999999~99999999 times the minimum unit. Take absolute value when negative.

J: The rectangle width in direction of Y axis, the range -99999999~99999999 times the minimum unit. Take absolute value when negative.

D: The number of tool, the range 0~32, D0 the default is 0. Take out the current tool radius according to the number which is specified

K: The distance from the starting point to the rectangle in direction of X axis, the range -99999999~99999999 times the minimum unit. Take absolute value when negative.

U: Corner radius of arc, omit means no corner arc to transition.

Cycle process:

- (1) Orient to the position of X Y plane;
- (2) Move to the R point plane;
- (3) Cutting feed to the hole bottom;
- (4) Start from starting point to arc interpolation with transition arc 1;
- (5) Process straight line and arc interpolation with 2-3;
- (6) Process arc interpolation to back to starting point with transition arc 4;

(7) Fixed back to R point.

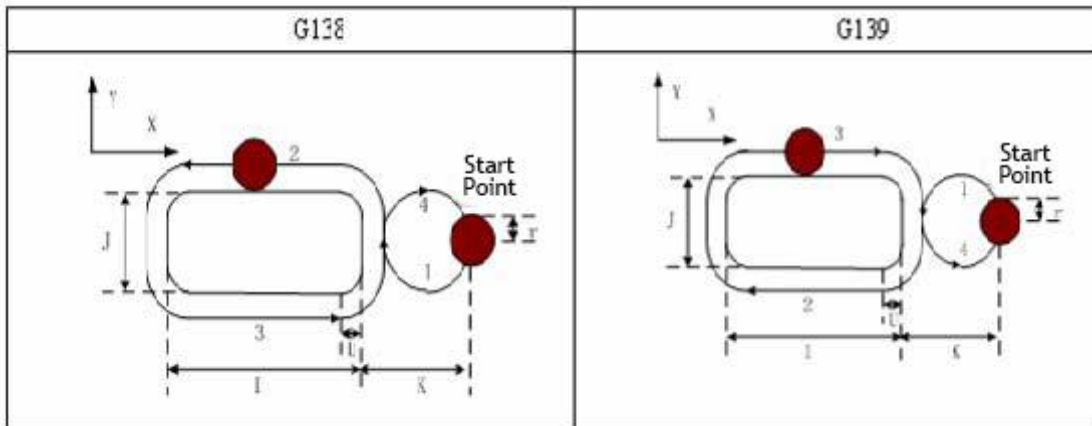

Note:

(1) The interpolation direction of transition arc and finishing milling arc is different, in finishing milling outside the rectangle, the interpolation direction means the direction of finishing milling arc.

(2) Q, P, L are invalid under the cycle, but it will keep the value of Q, P as the fixed mode cycle value.

Example: Use the fixed cycle G138 to do finishing milling.

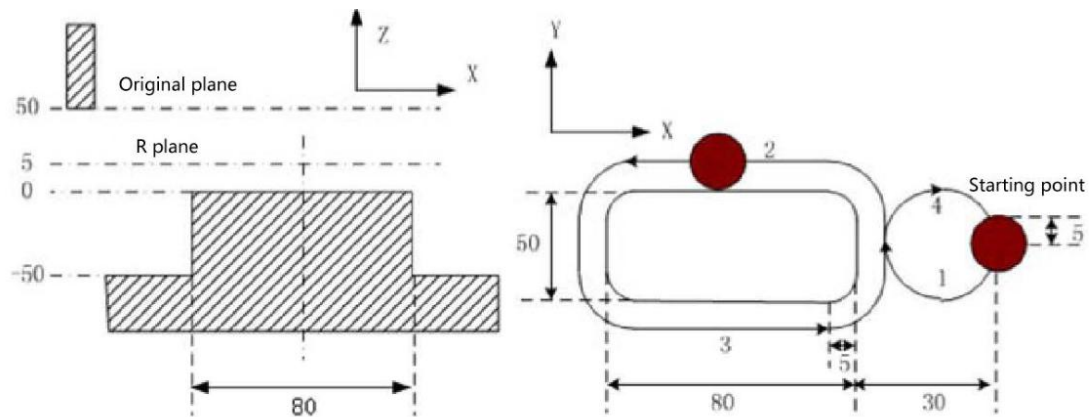

G90 G00 X50 Y50 Z50; (G00 to orient)

G99 G138 X25 Y25 R5 Z-50 I80 J50 K30 U5 F800 D1; (Process finishing milling outside the rectangle at the bottom of hole under the fixed cycle)

G80 X50 Y50 Z50; (Cancel the fixed cycle and return from R point plane)

M30;

(54) Programmable data input instruction G10/G710

Programmable input instruction is used to modify work piece coordinate in program, or offset work piece coordinate.

G10 Lxx ;open programmable data input

Px Rxx ;execute data modification

Px Lxx ;execute data modification

X_Y_Z_A_ ;set current coordinate of specified work piece coordinate

G710 ;close programmable data input

Note:

G10 means open programmable data input, modal instruction;

G710 means close programmable data input, modal instruction;

L address specifies data type, 54--59 matches G54-G59 offset value, 5401--5448 matches G54.1-G54.48 offset value, modal instruction;

P address specifies axis which will be modified, 1-8 corresponds to XYZABCXsYs, modal instruction;

R address specifies modify value, absolute value;

I address specifies modify value, incremental value;

Sample:

G10 L55 ;open programmable data input, set G55 coordinate offset value

P2 R6 ;Y axis of G55 coordinate offset set as 6mm

L56 X1Y2Z3;set G56 coordinate as X1Y2Z3

P1 I5 ;X axis of G56 coordinate add 1.5mm incrementally

G710 ;open programmable data input

(55) Programmable data input instruction G10

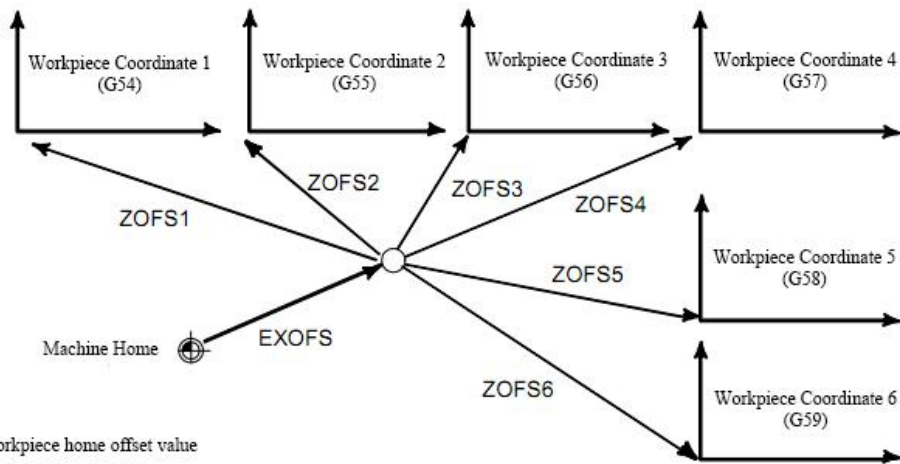

EXOFS: External workpiece home offset value
ZOFS1~ZOFS6: workpiece home offset

<1> when call L2, it means set external work piece coordinate or G54-G59 coordinate home offset value:

G10 L2 P_X_Y_Z_A_B_C_.....

P=0 means set external work piece coordinate home offset.

Method 1: P0 set external work piece coordinate home offset;

Method 2: when main interface shows G53 status, press F7 to set tool, and set external work piece coordinate offset.

Method 3: In coordinate interface, set P1-0=53, then P1-1/P1-8 can be used to set each axis offset value in external work piece coordinate.

When P=1--6, it corresponds to G54-G59 home offset value.

If current coordinate status is G90, then coordinate offset is absolute value. If current coordinate status is G91, then coordinate offset is incremental value.

When call L2, G10 is non-modal instruction, G10 L2 must be added in each line.

Sample:

G10 L2 P1 X0Y0Z0 G90 :G54 coordinate coincide external coordinate.

G10 L2 P3 X11Y22Z33 ;G56 and external coordinate offset X11mm, Y22mm, Z33mm.

<2> when call L20, it means set external work piece coordinate or G54.1-G54.48 coordinate home offset value:

G10 L20 P_X_Y_Z_A_B_C_.....

When P=1--48, it corresponds to G54.1-G54.48 home offset value.

If current coordinate status is G90, then coordinate offset is absolute value. If current coordinate status is G91, then coordinate offset is incremental value.

When call L20, G10 is non-modal instruction, G10 L20 must be added in each line.

Sample:

G10 L20 P1 X0Y0Z0 G90 :G54.1 coordinate coincide external coordinate.

G10 L20 P3 X11Y22Z33 ;G54.3 and external coordinate offset X11mm, Y22mm, Z33mm.

Note: when call L2 or L20, instruction is compatible with Fanuc system.

<3> External coordinate system setting and modification

1. manual mode, choose coordinate G53, then set coordinate.
2. in coordinate parameter, choose G53, then modify offset.
3. in tool compensation mode, modify external coordinate.

(56) Ellipse instruction(G602/G603)

Format: G17 G602/G603 X(U)_Y(V)_I_J_Q_
 G18 G602/G603 Z(W)_Y(V)_K_I_Q_
 G19 G602/G603 X(U)_Z(W)_J_K_Q_

I: semi-axis distance in X axis direction;

J: semi-axis distance in Y axis direction;

Q: oblique angle(unit:degree).

No matter diameter or radius program, address IJK are radius value, unite:mm.

G602 is clockwise ellipse, G603 is count-clockwise ellipse.

When semi-axis value defined by IJK are positive, it means central angle of ellipse is less than or equal to 180 degrees; when one or two value among IJK is negative, it means central angle of ellipse is bigger than or equal to 180 degrees.

Q defines ellipse rotary oblique angle around ellipse center, CCW direction of right-hand coordinate system is positive, unit: degree, without Q means no rotary oblique angle.

G602/G603 are mode instruction, and IJKQ are modeless.

(57) Parabola instruction(G702)

Format:

G17 G702 X(U)_Y(V)_R_Q_ corresponds to equation: $Y*Y=2*R*X$ (X:radius);

G18 G702 Z(W)_X(U)_R_Q_ corresponds to equation: $X*X=2*R*Z$ (X:radius);

G19 G702 Y(V)_Z(W)_R_Q_ corresponds to equation: $Z*Z=2*R*Y$.

R is parabola equation coefficient, means double of distance between focus and vertex, allowing positive or negative, unit:mm.

Q is rotary angle of parabola around vertex, CCW direction of right-hand coordinate system is positive, unit: degree, without Q means no rotary oblique angle.

G702 are mode instruction, and RQ are modeless.

Attention: R value allows positive or negative, corresponding to different direction of parabola, positive R means rightward parabola, negative R means leftward parabola.

4.5 Radius compensation C of tool

C means the system calculates the tool trajectory of radius compensation according to the last program line and the next program line.

4.5.1 Inside and outside

It calls inside when the included angle of tool trajectory is over 180 degrees which is built by two program segments, it calls outside when the included angle is between 0 and 180 degrees. As the follows:



4.5.2 Tool motion when starting

The radius compensation without tool builds tool radius compensation

(1) Tool motion around the inside corner ($\alpha \geq 180$)

The tool center will move to the tool vector radius vertex of the starting point in next program line.

Straight line->Straight line

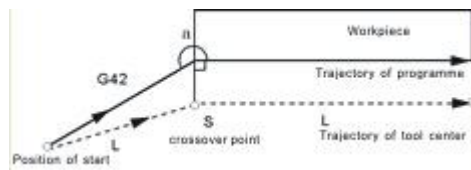

Straight line->Arc

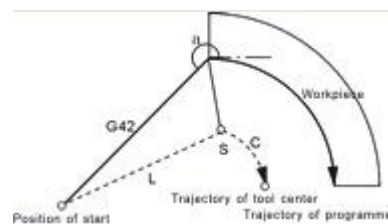

(2) The tool motion around the outside corner of obtuse angle ($90 \leq \alpha < 180$)

The tool center will move to the tool vector radius vertex of the end point in this program line.

Straight line->Straight line

A type

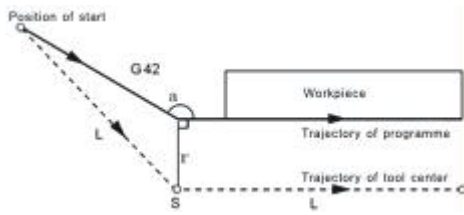

B type

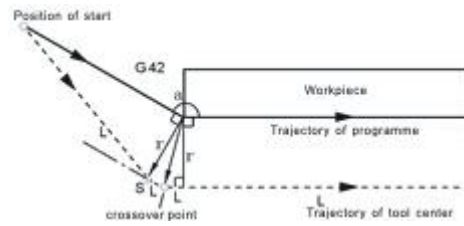

Straight line->Arc

A type

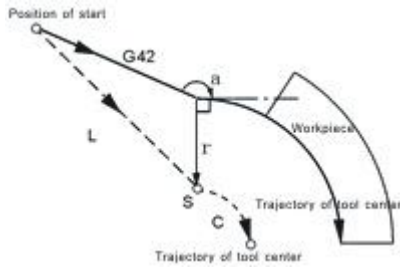

B type

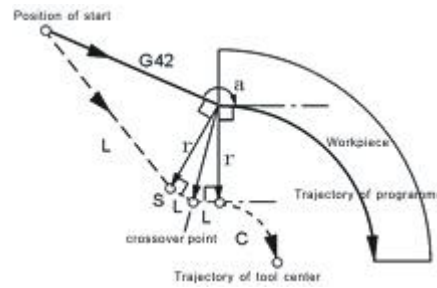

(3)The tool motion around the outside corner of acute angle ($\alpha < 90$)

The tool center will move to the tool vector radius vertex of the end point in this program line.

Straight line->Straight line

A type

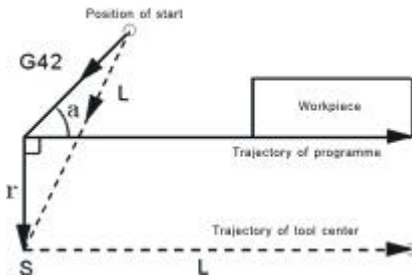

B type

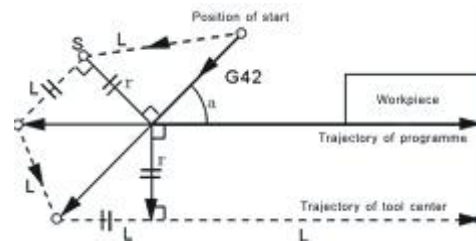

Straight line->Arc

A type

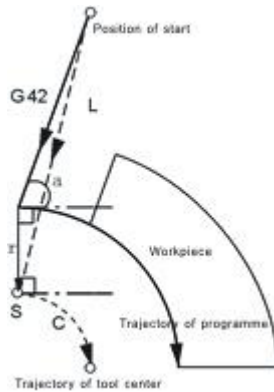

B type

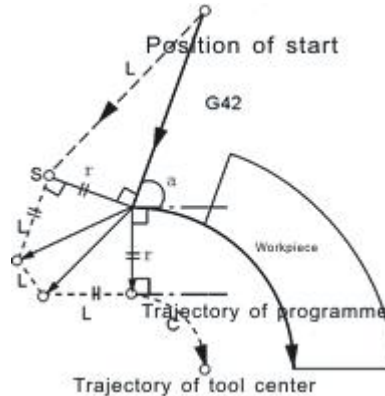

4.5.3 Tool motion in offset mode

(1) Tool motion around the inside corner ($180 \leq \alpha$)

Straight line->Straight line

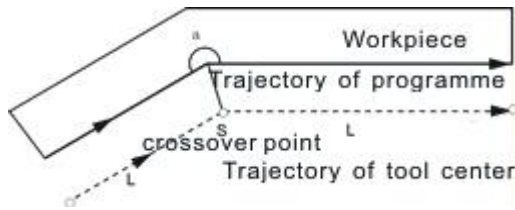

Straight line->Arc

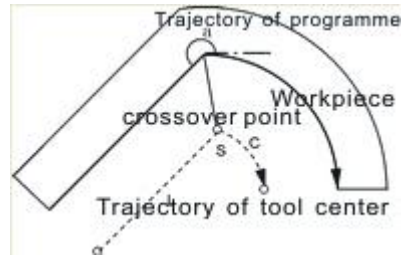

Arc-> Straight line

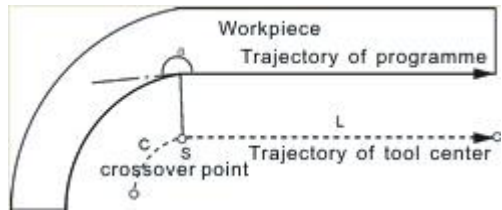

Arc->Arc

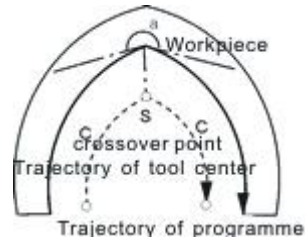

(2) The tool motion around the outside corner of obtuse angle ($90 \leq \alpha < 180$)

Straight line ->Straight line

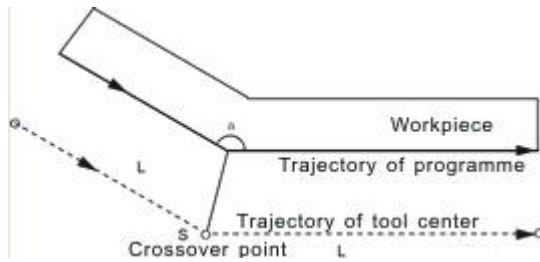

Straight line ->Arc

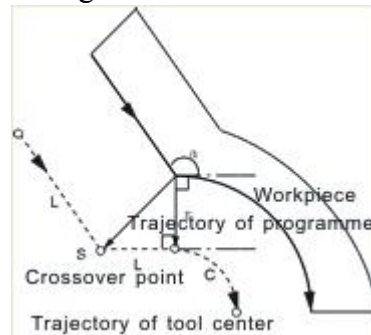

Arc-> Straight line

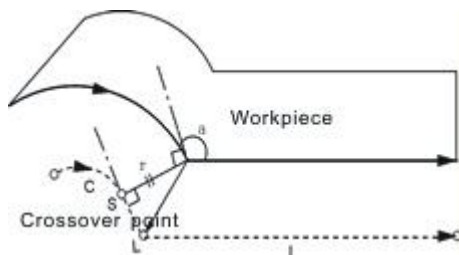

Arc->Arc

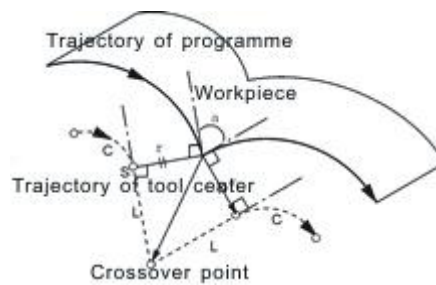

(3) The tool motion around the outside corner of acute angle ($\alpha < 90$)

Straight line->Straight line

Straight line->Arc

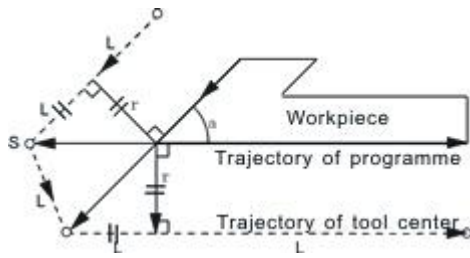

Arc-> Straight line

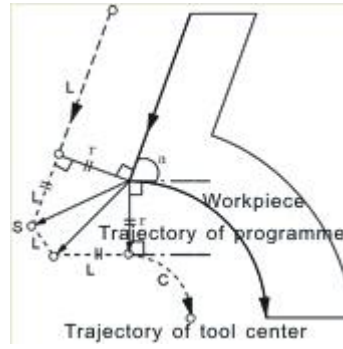

Arc->Arc

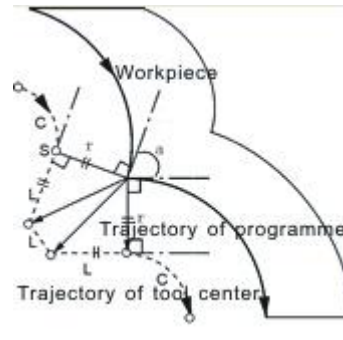
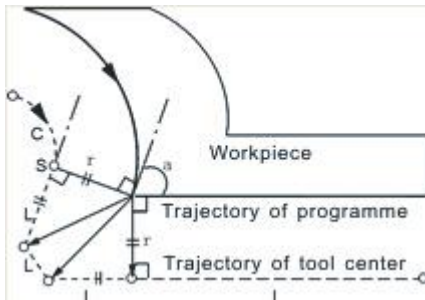

4.5.4 Tool motion in offset-cancel mode

(1) Tool motion around the inside corner ($180 \leq \alpha$)

The tool center will move to the tool vector radius vertex of the end point in this program line.

Straight line -> Straight line

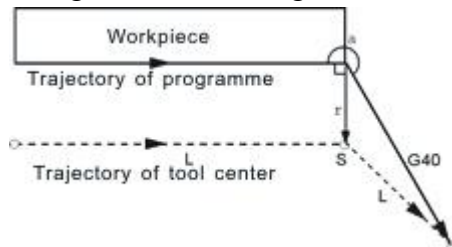

Arc -> Straight line

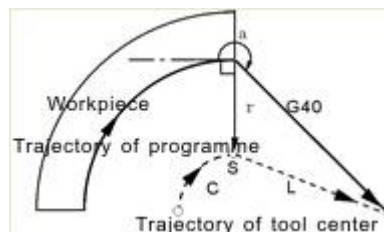

(2) The tool motion around the outside corner of obtuse angle ($90 \leq \alpha < 180$)

The tool center will move to the tool vector radius vertex of the starting point in next program line.

Straight line -> Straight line

A type

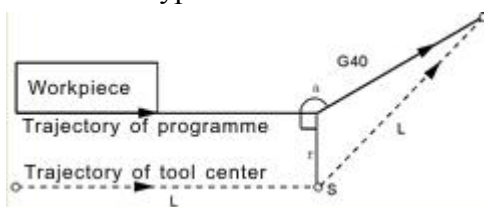

Arc -> Straight line

A type

B type

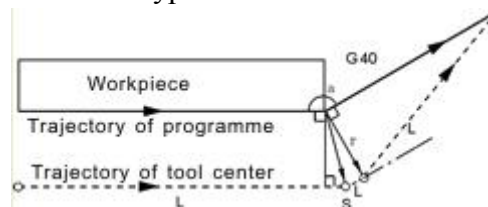

B type

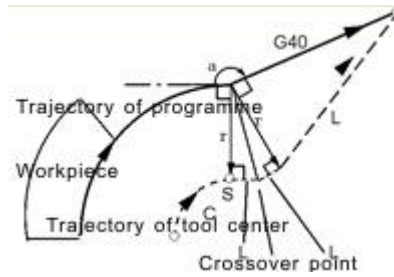
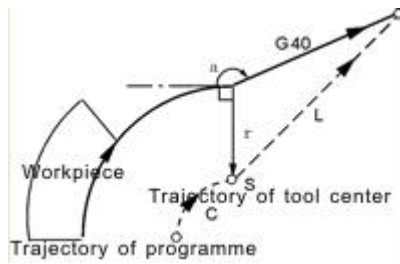

(3)The tool motion around the outside corner of acute angle ($\alpha < 90$)

The tool center will move to the tool vector radius vertex of the starting point in next program line.

Straight line \rightarrow Straight line

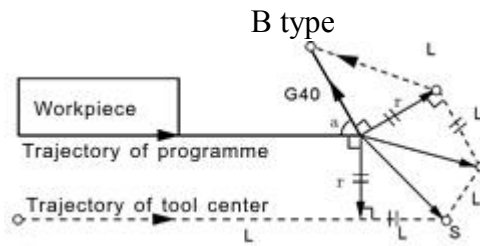
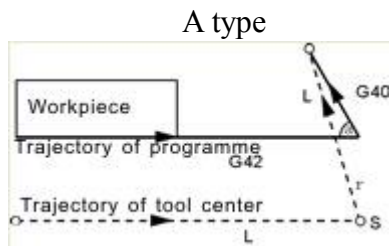

Arc \rightarrow Straight line

A type



B type

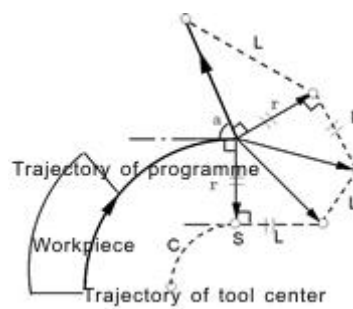

4.6 Comprehensive examples

In the actual programming, must according to the drawings and processing requirements to select the install method and suitable tool correctly, combined with the actual working performance of lathe to select the correct cutting allowance, for example:

Example 1: Cut square and cut circle

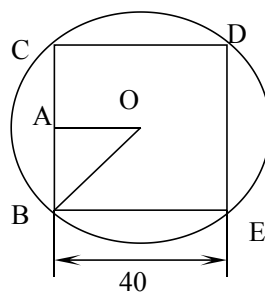

Beginning from the center, the center coordinate is G54 X0 Y0 Z50

The tool radius in the D01 of the T01 parameter

N0 G54 G00 X0 Y0 Z50	Starting point of processing
N1 M03 S1000	Turn on spindle
N2 G00 Y-40 X-40 G90	Move outside of square
N3 Z10	
N4 G01 Z-10 F200	Start cutting from Z axis
N5 G01 G41 T01 D01 X-20 Y-20 F400	Move to B point
N6 Y20	Tool cuts BC line at the left of the workpiece
N7 X20	Closed angle transition in C point, cut CD line
N8 Y-20	Closed angle transition in D point, cut DE line
N9 X-25	Closed angle transition in E point, cut CB line is for smooth, move 5mm more
N10 G00 X-40 Y-40 G40	Move outside of circle
N11 G01 G41 X-20 Y-20 F500	Lengthen T01 value along A-B
N12 Z-20 F100	Start cutting from Z axis
N13 G91 G02 I20 J20 Y0 X0	Circle of contact
N14 G00 Z50	End cutting
N15 G40 G00 X0 Y0	Cancel tool compensation
N16 M05	Turn off spindle
N17 M02	Program ends.

Example 2:

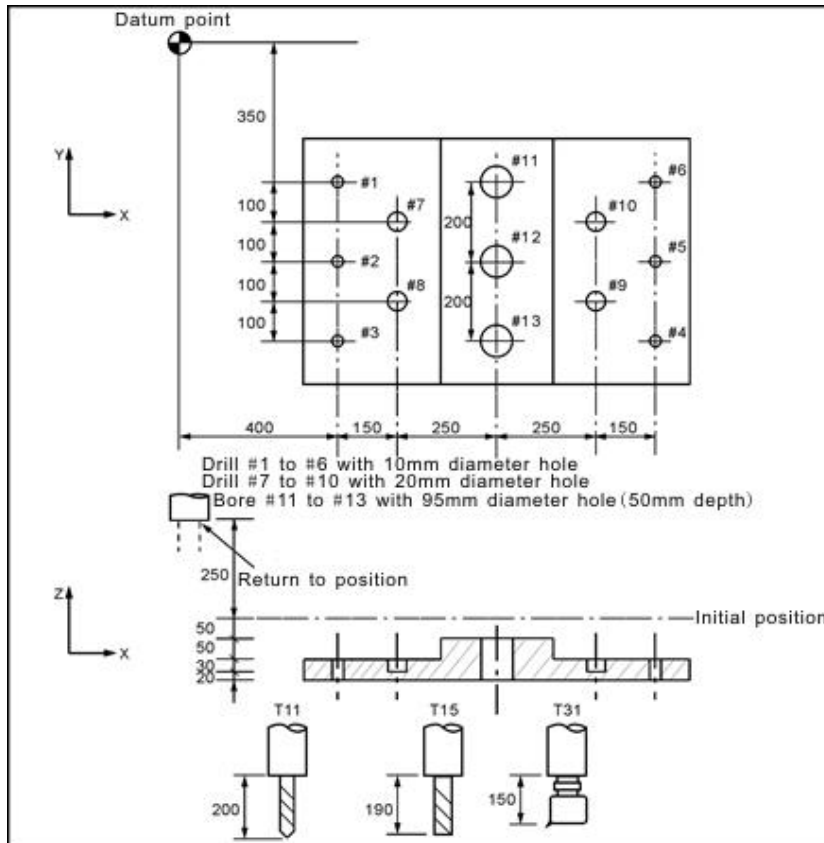

Assume to used 3 tools T11 T15 T31. The tool length compensation values were 200 (H1), 190 (H1), 150 (H1), entered into the tool parameter. According to the processing requirements of parts drawing, the program is as follows:

N1 G54 X0 Y0 Z0	Set workpiece coordinate at the home point
N2 G90 G00 Z250.0 T11	Tool exchange
N3 G43 Z0 H1	The offset length in initial position
N4 S30 M3	Turn on spindle
N5 G99 G81 X400.0 Y-350.0 Z-153.0 R-97.0 F120	To drill #1 hole
N6 Y-550.0	To drill #2 hole and return to initial position
N7 G98 Y-750.0	To drill #3 hole and return to initial position
N8 G99 X1200.0	To drill #4 hole and return to initial position
N9 Y-550.0	To drill #5 hole and return to initial position
N10 G98 Y-350.0	To drill #6 hole and return to initial position
N11 G00 X0 Y0 M5	Return to the home point and stop spindle

N12 G49 Z250.0 T15	Cancel the tool length offset to change tool
N13 G43 Z0 H1	Tool length offset in initial position
N14 S20 M3	Turn on spindle
N15 G99 G82 X550.0 Y-450.0 Z-130.0 R-97.0 F500	To drill #7 hole and return to initial position
N16 G98 Y-650.0	To drill #8 hole and return to initial position
N17 G99 X1050.0	To drill #9 hole and return to initial position
N18 G98 Y-450.0	To drill #10 hole and return to initial position
N19 G00 X0 Y0 M5	Return to the home point and stop spindle
N20 G49 Z250.0T31	Cancel the tool length offset to change tool
N21 G43 Z0 H1	Tool length offset in initial position
N22 S10 M3	Turn on spindle
N23 G85 G99 X800.0 Y-350.0 Z-153.0 R47.0 F150	To bore #11 hole and return to initial position
N24 G91 Y-200.0	To bore #12 hole and return to initial position
N25 Y-200.0	To bore #13 hole and return to initial position
N26 G90 G28 X0 Y0 M5	Return to the home point and stop spindle
N27 G49 Z0 G80	Cancel the tool length offset
N28 M02	Program ends.

4.7 Automatic tool setting gauge

1. Note for parameter:

Define macro variables of the automatic tool setting gauge function are as follows (corresponding to Other parameters P380 - P389):

#380: The X axis machine coordinate of initial position when automatic tool setting;(Unit:mm)

#381: The Y axis machine coordinate of initial position when automatic tool setting;(unit:mm)

#382: The Z axis machine coordinate of initial position and returning point with automatic tool setting;(unit:mm)

#383: The negative speed of automatic tool setting;(mm/min)

#384: The positive speed of automatic tool setting;(mm/min)

#385: The Z axis coordinate of work piece surface in current work piece coordinate system after automatic tool setting;(mm)

#386: The speed which is rapid move to locating position with automatic tool setting;(mm/min)

#387: Automatic tool setting mode (1 means fixed point, 0 means floating point).

#388: The minimal machine coordinate value of Z axis (mm);

#389: The gap value of Z axis [The height which is the gauge surface relative to the work piece surface(mm)];

Fixed point gauge means putting the gauge in a fixed position, every time the X Y Z axis are automatic running to the fixed point first in tool setting; But the floating point gauge search the tool setting gauge signal along negative of the Z axis.

The input point X25 is default to be the checking point of automatic tool setting gauge to input.

2.The instruction:

M880 (corresponding to ProgramUser0) automatic tool setting instruction;

M882 (corresponding to ProgramUser2),

M883 (corresponding to ProgramUser3) set the gap of Z axis.

3. Automatic tool setting steps:

1)Set the No.380--No.388 parameter in other parameter;

2)Set the No.389 parameter in other parameter to set the drop value of Z axis: this operation needs to be set only once.

A.Run M882 instruction in MDI to set the gap of Z axis;

B.Manual run Z axis to move the tool nose to the work piece surface;

C.Run M883 instruction in MDI to automatic set the gap of Z axis No.389 parameter in other parameter;

3) MDI choose the work piece coordinate system G54/G59;

4) Automatic tool setting: MDI running the M880 instruction, automatic set the Z axis offset of the current work piece coordinate system.

4.8 Automatic edge finder

1. The X axis edge: M884(Corresponding to ProgramUser4)

1) Choose the current coordinate system such as G54;

2) Manually moving the X to the negative terminal of workpiece; run M884 instruction in MDI;

3) Manually moving the Y to the positive terminal of workpiece; run M884 instruction in MDI, automatically divide the center of Y axis and set the middle point of workpiece as current coordinate system of Y axis origin, that's automatically setting the current coordinate system, such as the coordinate offset value of Y axis in G54.

2. The Y axis edge:M885 (Corresponding to ProgramUser5)

1) Choose the coordinate system such as G54;

2) Manually moving the Y to the negative terminal of workpiece; Run M885 instruction in MDI;

3) Manually moving the Y to the positive terminal of workpiece; Run M885 instruction in MDI, automatically divide the center of Y axis and set the center point of workpiece as the current coordinate system of Y axis origin, that's automatically setting the current coordinate system, such as the offset value of Y axis in G54.

3. Interior X axis edge: M886(Corresponding to ProgramUser6)

- 1) Choose the current coordinate system such as G54;
- 2) Manually moving X axis into interior of workpiece;
- 3) Run M885 instruction in MDI, controller will detect input point X31, then divide X axis coordinate automatically, and set middle point of work piece as X zero point of current coordinate system, finally move to X zero point.

4. Interior Y axis edge: M887(Corresponding to ProgramUser7)

- 1) Choose the current coordinate system such as G54;
- 2) Manually moving X axis into interior of workpiece;
- 3) Run M885 instruction in MDI, controller will detect input point X31, then divide Y axis coordinate automatically, and set middle point of work piece as Y zero point of current coordinate system, finally move to Y zero point.

Attention: when run M884-M887, external coordinate offset value should be 0.

4.9 Instruction of follow-up axis

1.Method A: the coordinate of follow-up axis will not follow, while the fourth axis can be hidden in screen. When axis parameter P414 is 7, the fourth axis is following X axis in both automatic and manual mode. When P414 is 8, the fourth axis is following Y axis in both automatic and manual mode. When P414 is 9, the fourth axis is following Z axis in both automatic and manual mode.

Besides, when P414 is 17/18/19, the C axis is following X/Y/Z axis in both automatic and manual mode. When P414 is 27/28/29, the B axis is following X/Y/Z axis in both automatic and manual mode.

2. Method B: it is applied to specify follow-up axis with instructions in automatic mode, but not follow in manual mode. In this way, is coordinate following when axis is following.

- M123: turn on the follow-up Y axis following X axis;
- M124: turn off the follow-up Y axis following X axis;
- M125: turn on the follow-up A axis following X axis;
- M126: turn off the follow-up A axis following X axis.

NEWKer



**Ideal and Practical CNC
Products Manufacturer**



NEWKer Website



NEWKer Youtube

CHENGDU NEWKer CNC-TECHNOLOGY CO., LTD

Address: Economic Headquarter E2, No.888 Chenglong Avenue,
Longquanyi District, Chengdu City, Sichuan Province,
the People's Republic of China.

Website: WWW.NEWKER-CNC.COM

Email: NEWKer.CNC@aliyun.com

Phone: 028-84601148

Fax: 028-84609226

Skype: Newker-CNC James

Whatsapp: +8618990029555